

**P7H55-M**

**ASUS**<sup>®</sup>

**Motherboard**

E5345

First Edition V1

January 2010

**Copyright © 2010 ASUSTeK Computer Inc. All Rights Reserved.**

No part of this manual, including the products and software described in it, may be reproduced, transmitted, transcribed, stored in a retrieval system, or translated into any language in any form or by any means, except documentation kept by the purchaser for backup purposes, without the express written permission of ASUSTeK Computer Inc. ("ASUS").

Product warranty or service will not be extended if: (1) the product is repaired, modified or altered, unless such repair, modification of alteration is authorized in writing by ASUS; or (2) the serial number of the product is defaced or missing.

ASUS PROVIDES THIS MANUAL "AS IS" WITHOUT WARRANTY OF ANY KIND, EITHER EXPRESS OR IMPLIED, INCLUDING BUT NOT LIMITED TO THE IMPLIED WARRANTIES OR CONDITIONS OF MERCHANTABILITY OR FITNESS FOR A PARTICULAR PURPOSE. IN NO EVENT SHALL ASUS, ITS DIRECTORS, OFFICERS, EMPLOYEES OR AGENTS BE LIABLE FOR ANY INDIRECT, SPECIAL, INCIDENTAL, OR CONSEQUENTIAL DAMAGES (INCLUDING DAMAGES FOR LOSS OF PROFITS, LOSS OF BUSINESS, LOSS OF USE OR DATA, INTERRUPTION OF BUSINESS AND THE LIKE), EVEN IF ASUS HAS BEEN ADVISED OF THE POSSIBILITY OF SUCH DAMAGES ARISING FROM ANY DEFECT OR ERROR IN THIS MANUAL OR PRODUCT.

SPECIFICATIONS AND INFORMATION CONTAINED IN THIS MANUAL ARE FURNISHED FOR INFORMATIONAL USE ONLY, AND ARE SUBJECT TO CHANGE AT ANY TIME WITHOUT NOTICE, AND SHOULD NOT BE CONSTRUED AS A COMMITMENT BY ASUS. ASUS ASSUMES NO RESPONSIBILITY OR LIABILITY FOR ANY ERRORS OR INACCURACIES THAT MAY APPEAR IN THIS MANUAL, INCLUDING THE PRODUCTS AND SOFTWARE DESCRIBED IN IT.

Products and corporate names appearing in this manual may or may not be registered trademarks or copyrights of their respective companies, and are used only for identification or explanation and to the owners' benefit, without intent to infringe.

#### **Offer to Provide Source Code of Certain Software**

This product may contain copyrighted software that is licensed under the General Public License ("GPL") and under the Lesser General Public License Version ("LGPL"). The GPL and LGPL licensed code in this product is distributed without any warranty. Copies of these licenses are included in this product.

You may obtain the complete corresponding source code (as defined in the GPL) for the GPL Software, and/or the complete corresponding source code of the LGPL Software (with the complete machine-readable "work that uses the Library") for a period of three years after our last shipment of the product including the GPL Software and/or LGPL Software, which will be no earlier than December 1, 2011, either

(1) for free by downloading it from <http://support.asus.com/download>;

or

(2) for the cost of reproduction and shipment, which is dependent on the preferred carrier and the location where you want to have it shipped to, by sending a request to:

ASUSTeK Computer Inc.  
Legal Compliance Dept.  
15 Li Te Rd.,  
Beitou, Taipei 112  
Taiwan

In your request please provide the name, model number and version, as stated in the About Box of the product for which you wish to obtain the corresponding source code and your contact details so that we can coordinate the terms and cost of shipment with you.

The source code will be distributed WITHOUT ANY WARRANTY and licensed under the same license as the corresponding binary/object code.

This offer is valid to anyone in receipt of this information.

ASUSTeK is eager to duly provide complete source code as required under various Free Open Source Software licenses. If however you encounter any problems in obtaining the full corresponding source code we would be much obliged if you give us a notification to the email address [gpl@asus.com](mailto:gpl@asus.com), stating the product and describing the problem (please do NOT send large attachments such as source code archives etc to this email address).

# Contents

Notices.....	vi
Safety information .....	vii
About this guide .....	vii
P7H55-M specifications summary.....	ix

## Chapter 1: Product introduction

<b>1.1</b>	<b>Welcome!</b> .....	<b>1-1</b>
<b>1.2</b>	<b>Package contents</b> .....	<b>1-1</b>
<b>1.3</b>	<b>Special features</b> .....	<b>1-1</b>
1.3.1	Product highlights .....	1-1
1.3.2	Innovative ASUS features.....	1-3
<b>1.4</b>	<b>Before you proceed</b> .....	<b>1-5</b>
<b>1.5</b>	<b>Motherboard overview</b> .....	<b>1-6</b>
1.5.1	Placement direction .....	1-6
1.5.2	Screw holes .....	1-6
1.5.3	Motherboard layout.....	1-7
1.5.4	Layout contents.....	1-7
<b>1.6</b>	<b>Central Processing Unit (CPU)</b> .....	<b>1-8</b>
1.6.1	Installing the CPU .....	1-8
1.6.2	Installing the CPU heatsink and fan.....	1-11
1.6.3	Uninstalling the CPU heatsink and fan .....	1-12
<b>1.7</b>	<b>System memory</b> .....	<b>1-13</b>
1.7.1	Overview .....	1-13
1.7.2	Memory configurations.....	1-14
1.7.3	Installing a DIMM .....	1-18
1.7.4	Removing a DIMM .....	1-18
<b>1.8</b>	<b>Expansion slots</b> .....	<b>1-19</b>
1.8.1	Installing an expansion card .....	1-19
1.8.2	Configuring an expansion card .....	1-19
1.8.3	PCI slot .....	1-19
1.8.4	PCI Express x1 slots.....	1-19
1.8.5	PCI Express x16 slot.....	1-19
<b>1.9</b>	<b>Jumpers</b> .....	<b>1-20</b>
<b>1.10</b>	<b>Connectors</b> .....	<b>1-21</b>
1.10.1	Rear panel connectors.....	1-21
1.10.2	Internal connectors .....	1-22

# Contents

- 1.11 Software support..... 1-28
  - 1.11.1 Installing an operating system ..... 1-28
  - 1.11.2 Support DVD information ..... 1-28

## Chapter 2: BIOS information

- 2.1 Managing and updating your BIOS ..... 2-1
  - 2.1.1 ASUS Update utility ..... 2-1
  - 2.1.2 ASUS EZ Flash 2 ..... 2-2
  - 2.1.3 ASUS CrashFree BIOS..... 2-3
  - 2.1.4 ASUS BIOS Updater ..... 2-3
- 2.2 BIOS setup program ..... 2-6
  - 2.2.1 BIOS menu screen..... 2-7
  - 2.2.2 Menu bar..... 2-7
  - 2.2.3 Navigation keys..... 2-7
  - 2.2.4 Menu items ..... 2-7
  - 2.2.5 Submenu items ..... 2-8
  - 2.2.6 Configuration fields ..... 2-8
  - 2.2.7 Pop-up window ..... 2-8
  - 2.2.8 Scroll bar..... 2-8
  - 2.2.9 General help ..... 2-8
- 2.3 Main menu ..... 2-8
  - 2.3.1 System Time ..... 2-9
  - 2.3.2 System Date ..... 2-9
  - 2.3.3 Language ..... 2-9
  - 2.3.4 SATA1~6 ..... 2-9
  - 2.3.5 Storage Configuration ..... 2-10
  - 2.3.6 System Information ..... 2-10
- 2.4 Ai Tweaker menu ..... 2-11
  - 2.4.1 Ai Overclock Tuner..... 2-11
  - 2.4.2 CPU Ratio Setting..... 2-12
  - 2.4.3 Intel(R) SpeedStep(TM) Tech ..... 2-12
  - 2.4.4 Xtreme Phase Full Power Mode ..... 2-12
  - 2.4.5 BCLK Frequency..... 2-13
  - 2.4.6 PCIE Frequency..... 2-13
  - 2.4.7 DRAM Frequency ..... 2-13
  - 2.4.8 QPI Frequency..... 2-13
  - 2.4.9 DRAM Timing Control ..... 2-13

# Contents

2.4.10	CPU Differential Amplitude.....	2-15
2.4.11	CPU Clock Skew.....	2-15
2.4.12	CPU Voltage Mode.....	2-15
2.4.13	IMC Voltage.....	2-15
2.4.14	DRAM Voltage.....	2-16
2.4.15	CPU PLL Voltage.....	2-16
2.4.16	PCH Voltage.....	2-16
2.4.17	DRAM DATA REF Voltage on CHA/B.....	2-16
2.4.18	Auto PSI.....	2-16
2.4.19	Load-Line Calibration.....	2-16
2.4.20	PCIe Spread Spectrum.....	2-16
2.4.11	PCI/PCIe CLK Status.....	2-16
<b>2.5</b>	<b>Advanced menu.....</b>	<b>2-17</b>
2.5.1	CPU Configuration.....	2-17
2.5.2	Uncore Configuration.....	2-19
2.5.3	Onboard Devices Configuration.....	2-19
2.5.4	USB Configuration.....	2-20
2.5.5	PCIePnP.....	2-20
2.5.6	Intel VT-d.....	2-20
<b>2.6</b>	<b>Power menu.....</b>	<b>2-21</b>
2.6.1	Suspend Mode.....	2-21
2.6.2	ACPI 2.0 Support.....	2-21
2.6.3	ACPI APIC Support.....	2-21
2.6.4	APM Configuration.....	2-21
2.6.5	Hardware Monitor.....	2-22
2.6.6	Anti Surge Support.....	2-23
<b>2.7</b>	<b>Boot menu.....</b>	<b>2-24</b>
2.7.1	Boot Device Priority.....	2-24
2.7.2	Boot Settings Configuration.....	2-24
2.7.3	Security.....	2-25
<b>2.8</b>	<b>Tools menu.....</b>	<b>2-26</b>
2.8.1	ASUS O.C. Profile.....	2-26
2.8.2	AI NET 2.....	2-27
2.8.3	ASUS EZ Flash 2.....	2-27
2.8.4	Express Gate.....	2-27
<b>2.9</b>	<b>Exit menu.....</b>	<b>2-28</b>

# Notices

## Federal Communications Commission Statement

This device complies with Part 15 of the FCC Rules. Operation is subject to the following two conditions:

- This device may not cause harmful interference, and
- This device must accept any interference received including interference that may cause undesired operation.

This equipment has been tested and found to comply with the limits for a Class B digital device, pursuant to Part 15 of the FCC Rules. These limits are designed to provide reasonable protection against harmful interference in a residential installation. This equipment generates, uses and can radiate radio frequency energy and, if not installed and used in accordance with manufacturer's instructions, may cause harmful interference to radio communications. However, there is no guarantee that interference will not occur in a particular installation. If this equipment does cause harmful interference to radio or television reception, which can be determined by turning the equipment off and on, the user is encouraged to try to correct the interference by one or more of the following measures:

- Reorient or relocate the receiving antenna.
- Increase the separation between the equipment and receiver.
- Connect the equipment to an outlet on a circuit different from that to which the receiver is connected.
- Consult the dealer or an experienced radio/TV technician for help.



---

The use of shielded cables for connection of the monitor to the graphics card is required to assure compliance with FCC regulations. Changes or modifications to this unit not expressly approved by the party responsible for compliance could void the user's authority to operate this equipment.

---

## Canadian Department of Communications Statement

This digital apparatus does not exceed the Class B limits for radio noise emissions from digital apparatus set out in the Radio Interference Regulations of the Canadian Department of Communications.

This class B digital apparatus complies with Canadian ICES-003.

## REACH

Complying with the REACH (Registration, Evaluation, Authorisation, and Restriction of Chemicals) regulatory framework, we published the chemical substances in our products at ASUS REACH website at <http://green.asus.com/english/REACH.htm>.



---

**DO NOT** throw the motherboard in municipal waste. This product has been designed to enable proper reuse of parts and recycling. This symbol of the crossed out wheeled bin indicates that the product (electrical and electronic equipment) should not be placed in municipal waste. Check local regulations for disposal of electronic products.

---



---

**DO NOT** throw the mercury-containing button cell battery in municipal waste. This symbol of the crossed out wheeled bin indicates that the battery should not be placed in municipal waste.

---

# Safety information

## Electrical safety

- To prevent electric shock hazard, disconnect the power cable from the electric outlet before relocating the system.
- When adding or removing devices to or from the system, ensure that the power cables for the devices are unplugged before the signal cables are connected. If possible, disconnect all power cables from the existing system before you add a device.
- Before connecting or removing signal cables from the motherboard, ensure that all power cables are unplugged.
- Seek professional assistance before using an adapter or extension cord. These devices could interrupt the grounding circuit.
- Ensure that your power supply is set to the correct voltage in your area. If you are not sure about the voltage of the electrical outlet you are using, contact your local power company.
- If the power supply is broken, do not try to fix it by yourself. Contact a qualified service technician or your retailer.

## Operation safety

- Before installing the motherboard and adding devices on it, carefully read all the manuals that came with the package.
- Before using the product, ensure that all cables are correctly connected and the power cables are not damaged. If you detect any damage, contact your dealer immediately.
- To avoid short circuits, keep paper clips, screws, and staples away from connectors, slots, sockets and circuitry.
- Avoid dust, humidity, and temperature extremes. Do not place the product in any area where it may become wet.
- Place the product on a stable surface.
- If you encounter technical problems with the product, contact a qualified service technician or your retailer.

## About this guide

This user guide contains the information you need when installing and configuring the motherboard.

### How this guide is organized

This guide contains the following parts:

- **Chapter 1: Product introduction**

This chapter describes the features of the motherboard and the new technology it supports.

- **Chapter 2: BIOS information**

This chapter tells how to change system settings through the BIOS Setup menus. Detailed descriptions of the BIOS parameters are also provided.

## Conventions used in this guide

To ensure that you perform certain tasks properly, take note of the following symbols used throughout this manual.



**DANGER/WARNING:** Information to prevent injury to yourself when trying to complete a task.



**CAUTION:** Information to prevent damage to the components when trying to complete a task.



**IMPORTANT:** Instructions that you **MUST** follow to complete a task.



**NOTE:** Tips and additional information to help you complete a task.

## Where to find more information

Refer to the following sources for additional information and for product and software updates.

### 1. ASUS websites

The ASUS website provides updated information on ASUS hardware and software products. Refer to the ASUS contact information.

### 2. Optional documentation

Your product package may include optional documentation, such as warranty flyers, that may have been added by your dealer. These documents are not part of the standard package.

## Typography

### **Bold text**

Indicates a menu or an item to select.

### *Italics*

Used to emphasize a word or a phrase.

### <Key>

Keys enclosed in the less-than and greater-than sign means that you must press the enclosed key.

Example: <Enter> means that you must press the Enter or Return key.

### <Key1>+<Key2>+<Key3>

If you must press two or more keys simultaneously, the key names are linked with a plus sign (+).

Example: <Ctrl>+<Alt>+<D>



## P7H55-M specifications summary

<b>CPU</b>	<p>LGA1156 socket for Intel® Core™ i7/ Core™ i5/ Core™ i3/ Pentium® processors</p> <p>Supports Intel® Turbo Boost Technology</p> <p>* The Intel® Turbo Boost Technology support depends on the CPU types.</p> <p>** Refer to <a href="http://www.asus.com">www.asus.com</a> for Intel® CPU support list.</p>
<b>Chipset</b>	Intel® H55 Express Chipset
<b>Memory</b>	<p>Dual-channel memory architecture</p> <p>4 x 240-pin DIMM slots support maximum 16GB unbuffered non-ECC DDR3 2200(O.C.)/ 2133/ 1866/ 1800/ 1600/ 1333/ 1066MHz memory modules</p> <p>* To achieve DDR3's frequency of 2200 MHz, use an Intel Core i7/ Core i5 CPU without the iGPU feature and install a VGA card. If you use Intel Core i5/ Core i3/ Pentium CPU with the iGPU feature, the maximum frequency is around 1600 MHz.</p> <p>** Supports Intel® Extreme Memory Profile (XMP)</p> <p>*** Hyper DIMM support is subject to the physical characteristics of individual CPUs. Some hyper DIMMs only support one DIMM per channel.</p> <p>**** Refer to <a href="http://www.asus.com">www.asus.com</a> for the latest Memory QVL (Qualified Vendors List).</p> <p>***** When you install a total memory of 4GB or more, Windows® 32-bit operating system may only recognize less than 3GB. We recommend a maximum of 3GB system memory if you are using a Windows® 32-bit operating system.</p>
<b>Expansion slots</b>	<p>1 x PCI Express™ 2.0 x16 slot</p> <p>2 x PCI Express™ 2.0 x1 slots (2.5GT/s, gray slots)</p> <p>1 x PCI slot</p>
<b>VGA</b>	<p>Multi-VGA output support: HDMI and RGB ports</p> <p>Supports HDMI with max. resolution of 1920x 1200 (@ 60Hz)</p> <p>Supports RGB with max. resolution of 2048x 1536 (@ 75 Hz)</p> <p>Maximum shared memory of 1748 MB</p>
<b>Storage</b>	<p>Intel® H55 Express Chipset:</p> <ul style="list-style-type: none"> <li>- 6 x SATA 3.0 Gb/s connectors</li> </ul> <p>VIA® VT6415 PATA controller:</p> <ul style="list-style-type: none"> <li>- 1 x Ultra DMA 133/100 connector for up to 2 PATA devices</li> </ul>
<b>LAN</b>	Realtek® RTL8111E Gigabit LAN controller featuring AI NET2
<b>USB</b>	Supports up to 12 USB 2.0/1.1 ports (6 ports at mid-board, 6 ports at the back panel)

(continued on the next page)

## P7H55-M specifications summary

<b>Audio</b>	Realtek® ALC887 8-channel* High Definition Audio CODEC <ul style="list-style-type: none"> <li>- Optical S/PDIF out ports at mid-board and back I/O</li> <li>- Support Jack-detection, Multi-streaming, Front Panel Jack-Retasking (Only in Mic in port)</li> </ul> * Use a chassis with HD audio module in the front panel to support an 8-channel audio output.
<b>ASUS unique features</b>	<b>ASUS Exclusive Overclocking Features:</b> <ul style="list-style-type: none"> <li>- GPU Boost</li> <li>- ASUS TurboV</li> <li>- ASUS Turbo Key</li> </ul> <b>ASUS Power Solutions:</b> <ul style="list-style-type: none"> <li>- ASUS EPU</li> </ul> <b>ASUS Quiet Thermal Solution:</b> <ul style="list-style-type: none"> <li>- ASUS Fanless Design: Stylish Heatsink Solution</li> </ul> <b>ASUS EZ DIY:</b> <ul style="list-style-type: none"> <li>- ASUS O.C. Profile</li> <li>- ASUS CrashFree BIOS 3</li> <li>- ASUS EZ Flash 2</li> <li>- ASUS My Logo 2</li> </ul> <b>ASUS Express Gate</b>
<b>ASUS exclusive overclocking features</b>	<b>Precision Tweaker 2:</b> <ul style="list-style-type: none"> <li>- vCore: Adjustable CPU voltage at 0.00625V increment</li> <li>- vIMC: Adjustable IMC voltage at 0.00625V increment</li> <li>- vDRAM Bus: Adjustable DRAM voltage at 0.015V increment</li> <li>- vPCH: Adjustable PCH voltage at 0.00625V increment</li> <li>- vCPU_PLL: Adjustable CPU_PLL voltage at 0.05V increment</li> <li>- iGPU: Adjustable iGPU voltage at 0.00625V increment</li> </ul> <b>SFS (Stepless Frequency Selection):</b> <ul style="list-style-type: none"> <li>- Internal Base Clock tuning from 80 MHz up to 500 MHz at 1MHz increment</li> <li>- PCI Express frequency tuning from 100MHz up to 200MHz at 1MHz increment (only for Lynnfield CPUs)</li> </ul> <b>Overclocking Protection:</b> <ul style="list-style-type: none"> <li>- ASUS C.P.R.(CPU Parameter Recall)</li> </ul>
<b>Back panel I/O ports</b>	1 x PS/2 Keyboard / Mouse Combo port 1 x Optical S/PDIF Out port 1 x HDMI port 1 x VGA port 1 x LAN (RJ-45) port 6 x USB 2.0/1.1 ports 3 x audio Jacks (8-channel)

(continued on the next page)

## P7H55-M specifications summary

<b>Internal I/O connectors</b>	3 x USB 2.0/1.1 connectors support additional 6 USB 2.0/1.1 ports 1 x IDE connector 6 x SATA connectors 1 x CPU fan connector (4-pin) 1 x Chassis fan connector (3-pin) 1 x Front panel audio connector 1 x S/PDIF Out header 1 x COM connector 1 x LPT connector 1 x 24-pin EATX power connector 1 x 8-pin ATX 12V power connector 1 x System panel connector
<b>BIOS</b>	64 Mb Flash ROM, SPI, AMI BIOS, PnP, DMI 2.0, WfM 2.0, SM BIOS 2.6, ACPI 2.0a, Multi-language BIOS, ASUS EZ Flash 2, ASUS CrashFree BIOS 3
<b>Manageability</b>	WfM 2.0, DMI 2.0, WOL by PME, WOR by PME, PXE
<b>Accessories</b>	1 x Ultra DMA 133/100 cable 2 x Serial ATA 3.0Gb/s cables 1 x I/O shield 1 x User Manual
<b>Support DVD</b>	Drivers ASUS Utilities ASUS Update Anti-virus software (OEM version)
<b>Form factor</b>	uATX form factor: 9.6 in x 8.8 in (24.4 cm x 22.4 cm)

\* Specifications are subject to change without notice.

[www.carlosmendoza.com.mx](http://www.carlosmendoza.com.mx)

# Chapter 1

## Product introduction

### 1.1 Welcome!

Thank you for buying an ASUS® P7H55-M motherboard!

The motherboard delivers a host of new features and latest technologies, making it another standout in the long line of ASUS quality motherboards!

Before you start installing the motherboard, and hardware devices on it, check the items in your package with the list below.

### 1.2 Package contents

Check your motherboard package for the following items.

<b>Motherboard</b>	ASUS P7H55-M motherboard
<b>Cables</b>	2 x Serial ATA 3.0Gb/s cables 1 x Ultra DMA 133/100 cable
<b>Accessories</b>	1 x I/O shield
<b>Application DVD</b>	ASUS motherboard support DVD
<b>Documentation</b>	User Manual



If any of the above items is damaged or missing, contact your retailer.

### 1.3 Special features

#### 1.3.1 Product highlights



#### Intel® LGA1156 Lynnfield / Clarkdale Processor Ready

This motherboard supports the latest Intel® Lynnfield and Clarkdale processors in LGA1156 package, which has memory and PCI Express controller integrated to support 2-channel (4 DIMMs) DDR3 memory and 16 PCI Express 2.0 lanes, providing great graphics performance. Intel® Lynnfield processor is one of the most powerful and energy efficient CPU in the world. Moreover, Intel® and Clarkdale processor integrated Graphics Procession Unit (GPU) which goes with Intel® H55 chipset with VGA out can bring you to the whole new experience of the next generation VGA performance. It also provides separated 3D, 2D, and Video Engines to execute different graphic control in hardware.



## Intel® H55

The Intel® H55 Express Chipset is the latest one-chipset design to support the latest 1156 socket Intel® Core™ i7 / Core™ i5/ Core™ i3/ Pentium® processors. Intel® H55 provides improved performance by utilizing serial point-to-point links, allowing increased bandwidth and stability. Use Intel® Core™ i5 6 Series, Core™ i3 5 Series, and Pentium® CPU with H55 Express Chipset to enjoy the latest Intel® integrated graphic performance.



## Dual-Channel DDR3 up to 2200 (O.C.) MHz support

The motherboard supports DDR3 memory that features data transfer rates up to 2200 (O.C.) MHz to meet the higher bandwidth requirements of the latest 3D graphics, multimedia, and Internet applications. The dual-channel DDR3 architecture enlarges the bandwidth of your system memory to boost system performance.



## PCI Express 2.0 support

This motherboard supports PCI Express 2.0 devices for double speed and bandwidth which enhances system performance.



## HDMI support

HDMI (High-Definition Multimedia Interface) is a set of digital video standards that deliver multi-channel digital audio and uncompressed digital video for full HD 1080p visuals through a single cable. Supporting HDCP copy protection such as HD DVD and Blu-ray discs, HDMI provides you with the highest-quality home theater experience.



## S/PDIF digital sound ready

This motherboard provides convenient connectivity to external home theater audio systems via the S/PDIF-out (SONY-PHILIPS Digital Interface) jack. It allows digital audio transfer and keeps the best signal quality.



## 8-channel audio CODEC

Enjoy high-end sound quality on your PC! The onboard 8-channel High Definition Audio CODEC enables high-quality 192KHz/24-bit audio output, jack-sensing feature, and multi-streaming technology.



## Gigabit LAN solution

The onboard LAN controller is a highly integrated Gb LAN controller. It is enhanced with an ACPI management function to provide efficient power management for advanced operating systems.

## 1.3.2 Innovative ASUS features



### Turbo Key

ASUS Turbo Key allows you to turn the PC power button into a physical overclocking button. After the easy setup, Turbo Key can boost performances without interrupting ongoing work or games—with just one touch!



### ASUS TurboV

Feel the adrenaline rush of real-time OC—now a reality with the ASUS TurboV. This easy OC tool allows you to overclock without exiting or rebooting the OS; and its user-friendly interface makes overclock with just a few clicks away. Moreover, the ASUS OC profiles in TurboV provides the best O.C. settings in different scenarios.



### GPU Boost

GPU Boost overclocks the integrated GPU in real time for the best graphics performance. User-friendly UI facilitates flexible frequency and voltage adjustments. Its ability to deliver multiple overclocking profiles also provides rapid and stable system-level upgrades.



### ASUS EPU

ASUS EPU is a unique power saving technology that detects the current system loadings and adjusts the power consumption in real time.



### ASUS Express Gate

Express Gate is an ASUS exclusive OS, which lets you instantly access the Internet and key applications before entering the Windows® OS.



- ASUS Express Gate supports installation on SATA HDDs, USB HDDs and flash drives with at least 1.2GB free disk space. When installing it on USB HDDs or flash drives, connect the drives to the motherboard USB port before turning on the computer.
- The actual boot time depends on the system configuration.
- ASUS Express Gate supports file uploading from SATA HDDs, ODDs and USB drives. It supports file downloading to USB drives only.



### Stylish Heatsink

The crystal-shaped heatsink features 0-dB thermal solution that offers users a noiseless PC environment. Not only the beautiful shape upgrades the visual enjoyment for motherboard users, but also the heatsink design lowers the temperature of the chipset and power phase area through high efficient heat-exchange. Combined with usability and aesthetics, the ASUS crystal-shaped heatsink will give users an extremely silent and cooling experience with the elegant appearance!



### ASUS O.C. Profile

The motherboard features the ASUS O.C. Profile that allows you to conveniently store or load multiple BIOS settings. The BIOS settings can be stored in the CMOS or a separate file, giving you the freedom to share and distribute your favorite settings.



### ASUS MyLogo2™

This feature allows you to convert your favorite photo into a 256-color boot logo for a more colorful and vivid image on your screen.



### ASUS CrashFree BIOS 3

ASUS CrashFree BIOS 3 is an auto-recovery tool that allows you to restore a corrupted BIOS file using the bundled support DVD or USB flash disk that contains the latest BIOS file.



### ASUS EZ Flash 2

ASUS EZ Flash 2 is a utility that allows you to update the BIOS without using an OS-based utility.



### ASUS AI NET2

ASUS AI NET2 remotely detects the cable connection immediately after turning on the system, and any faulty cable connections are reported back up to 100 meters at 1 meter accuracy.



### C.P.R. (CPU Parameter Recall)

The BIOS C.P.R. feature automatically restores the CPU default settings when the system hangs due to overclocking failure. C.P.R. eliminates the need to open the system chassis and clear the RTC data. Simply shut down and reboot the system, and the BIOS automatically restores the CPU parameters to their default settings.



### Green ASUS

This motherboard and its packaging comply with the European Union's Restriction on the use of Hazardous Substances (RoHS). This is in line with the ASUS vision of creating environment-friendly and recyclable products/packaging to safeguard consumers' health while minimizing the impact on the environment.



## 1.4 Before you proceed

Take note of the following precautions before you install motherboard components or change any motherboard settings.



- Unplug the power cord from the wall socket before touching any component.
- Before handling components, use a grounded wrist strap or touch a safely grounded object or a metal object, such as the power supply case, to avoid damaging them due to static electricity.
- Hold components by the edges to avoid touching the ICs on them.
- Whenever you uninstall any component, place it on a grounded antistatic pad or in the bag that came with the component.
- Before you install or remove any component, ensure that the ATX power supply is switched off or the power cord is detached from the power supply. Failure to do so may cause severe damage to the motherboard, peripherals, or components.

### Onboard LED

The motherboard comes with a standby power LED that lights up to indicate that the system is ON, in sleep mode, or in soft-off mode. This is a reminder that you must shut down the system and unplug the power cable before removing or plugging in any motherboard component. The illustration below shows the location of the onboard LED.

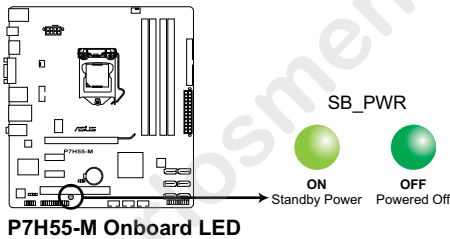

## 1.5 Motherboard overview

Before you install the motherboard, study the configuration of your chassis to ensure that the motherboard fits into it.



Ensure that you unplug the power cord before installing or removing the motherboard. Failure to do so can cause you physical injury and damage motherboard components.

### 1.5.1 Placement direction

When installing the motherboard, ensure that you place it into the chassis in the correct orientation. The edge with external ports goes to the rear part of the chassis as indicated in the image below.

### 1.5.2 Screw holes

Place six screws into the holes indicated by circles to secure the motherboard to the chassis.



Do not overtighten the screws! Doing so can damage the motherboard.

Place this side towards  
the rear of the chassis

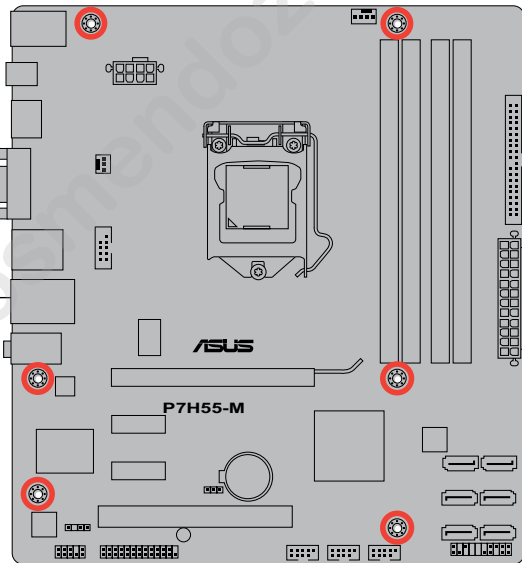

## 1.5.3 Motherboard layout

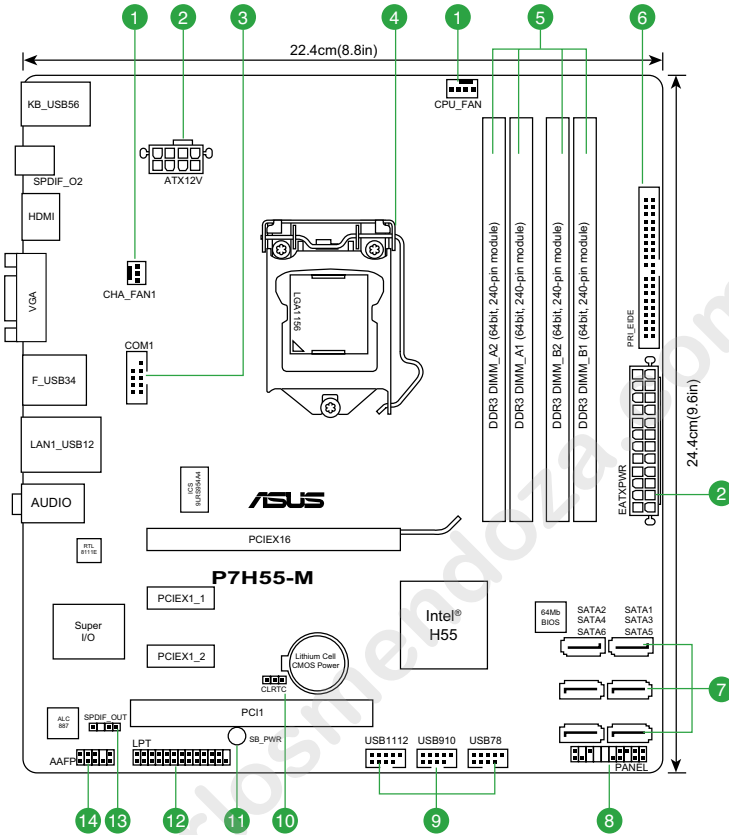

## 1.5.4 Layout contents

Connectors/Jumpers/Slots/LED	Page	Connectors/Jumpers/Slots/LED	Page
1. CPU and chassis fan connectors (4-pin CPU_FAN, 3-pin CHA_FAN1)	1-25	8. System panel connector (20-8 pin PANEL)	1-27
2. ATX power connectors (24-pin EATXPWR, 8-pin ATX12V)	1-24	9. USB connectors (10-1 pin USB78, USB910, USB1112)	1-26
3. Serial port connector (10-1 pin COM1)	1-24	10. Clear RTC RAM (3-pin CLRTC)	1-20
4. LGA1156 CPU socket	1-8	11. Onboard LED (SB_PWR)	1-5
5. DDR3 DIMM slots	1-13	12. LPT connector (26-1 pin LPT)	1-23
6. IDE connector (40-1 pin PRI_EIDE)	1-23	13. Digital audio connector (4-1 pin SPDIF_OUT)	1-25
7. Serial ATA connectors (7-pin SATA1-6)	1-26	14. Front panel audio connector (10-1 pin AAFP)	1-22

## 1.6 Central Processing Unit (CPU)

The motherboard comes with a surface mount LGA1156 socket designed for the Intel® Core™ i7 / Core™ i5 / Core™ i3 / Pentium® processors.



Unplug all power cables before installing the CPU.



- Upon purchase of the motherboard, ensure that the PnP cap is on the socket and the socket contacts are not bent. Contact your retailer immediately if the PnP cap is missing, or if you see any damage to the PnP cap/socket contacts/motherboard components. ASUS will shoulder the cost of repair only if the damage is shipment/transit-related.
- Keep the cap after installing the motherboard. ASUS will process Return Merchandise Authorization (RMA) requests only if the motherboard comes with the cap on the LGA1156 socket.
- The product warranty does not cover damage to the socket contacts resulting from incorrect CPU installation/removal, or misplacement/loss/incorrect removal of the PnP cap.

### 1.6.1 Installing the CPU

To install a CPU:

1. Locate the CPU socket on the motherboard.

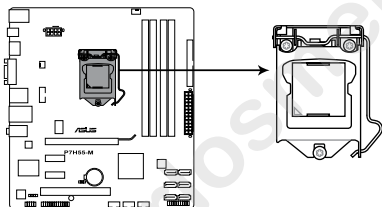

**P7H55-M CPU socket LGA1156**

2. Press the load lever with your thumb (A), and then move it to the right (B) until it is released from the retention tab.



To prevent damage to the socket pins, do not remove the PnP cap unless you are installing a CPU.

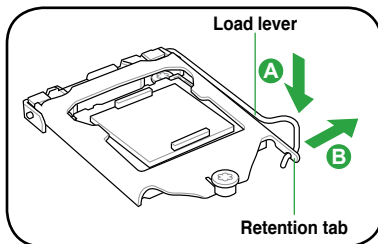

- Lift the load lever in the direction of the arrow until the load plate is completely lifted.

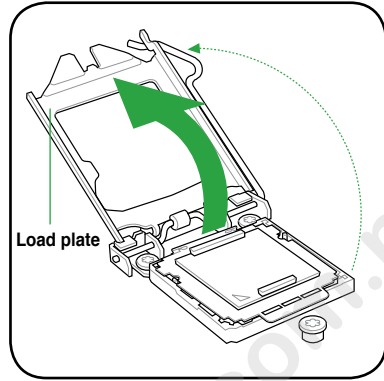

- Remove the PnP cap from the CPU socket by lifting the tab only.

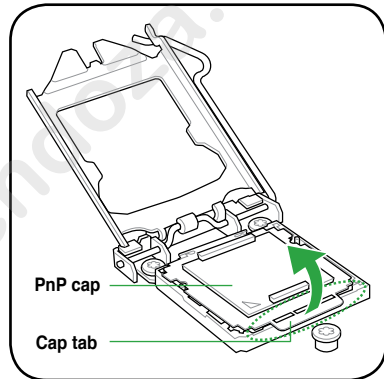

- Position the CPU over the socket, ensuring that the gold triangle is on the bottom-left corner of the socket, and then fit the socket alignment keys into the CPU notches.



The CPU fits in only one correct orientation. DO NOT force the CPU into the socket to prevent bending the connectors on the socket and damaging the CPU!

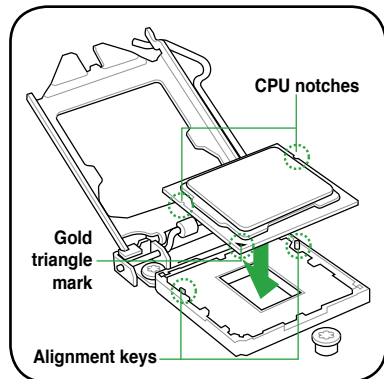

6. Apply some Thermal Interface Material to the exposed area of the CPU that the heatsink will be in contact with, ensuring that it is spread in an even thin layer.



Some heatsinks come with pre-applied thermal paste. If so, skip this step.



The Thermal Interface Material is toxic and inedible. DO NOT eat it. If it gets into your eyes or touches your skin, wash it off immediately, and seek professional medical help.

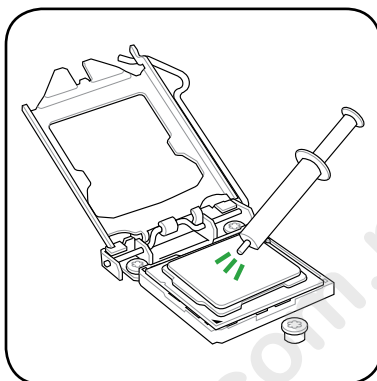

7. Close the load plate (A), and then push down the load lever (B), ensuring that the front edge of the load plate slides under the retention knob (C).

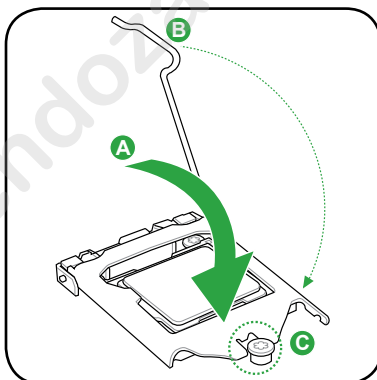

8. Insert the load lever under the retention tab.

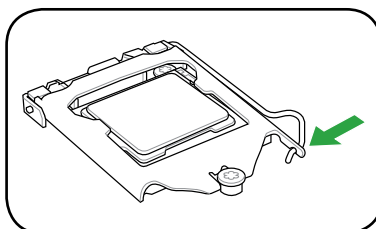

## 1.6.2 Installing the CPU heatsink and fan

The Intel® LGA1156 processor requires a specially designed heatsink and fan assembly to ensure optimum thermal condition and performance.



- When you buy a boxed Intel® processor, the package includes the CPU fan and heatsink assembly. If you buy a CPU separately, ensure that you use only Intel®-certified multi-directional heatsink and fan.
- Your Intel® LGA1156 heatsink and fan assembly comes in a push-pin design and requires no tool to install.
- Use an LGA1156-compatible CPU heatsink and fan assembly only. The LGA1156 socket is incompatible with the LGA775 and LGA1366 sockets in size and dimension.



If you purchased a separate CPU heatsink and fan assembly, ensure that you have properly applied Thermal Interface Material to the CPU heatsink or CPU before you install the heatsink and fan assembly.



Ensure that you have installed the motherboard to the chassis before you install the CPU fan and heatsink assembly.

To install the CPU heatsink and fan:

1. Place the heatsink on top of the installed CPU, ensuring that the four fasteners match the holes on the motherboard.



Orient the heatsink and fan assembly such that the CPU fan cable is closest to the CPU fan connector.

2. Push down two fasteners at a time in a diagonal sequence to secure the heatsink and fan assembly in place.

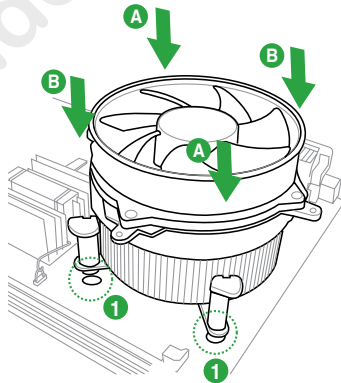
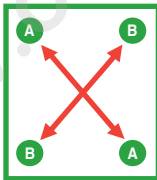

The type of CPU heatsink and fan assembly may differ, but the installation steps and functions should remain the same. The illustration above is for reference only.

3. Connect the CPU fan cable to the connector on the motherboard labeled CPU\_FAN.

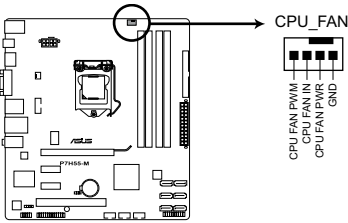

**P7H55-M CPU fan connector**



Do not forget to connect the CPU fan connector! Hardware monitoring errors can occur if you fail to plug this connector.

### 1.6.3 Uninstalling the CPU heatsink and fan

To uninstall the CPU heatsink and fan:

1. Disconnect the CPU fan cable from the connector on the motherboard.
2. Rotate each fastener counterclockwise.
3. Pull up two fasteners at a time in a diagonal sequence to disengage the heatsink and fan assembly from the motherboard.

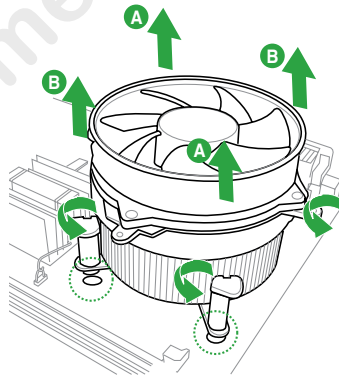
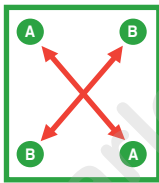



- Carefully remove the heatsink and fan assembly from the motherboard.
- Rotate each fastener clockwise to ensure correct orientation when reinstalling.

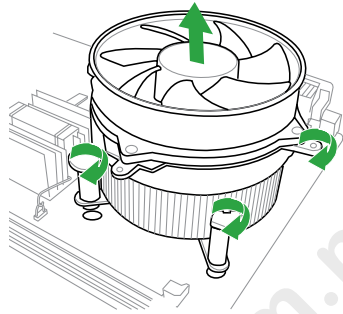

## 1.7 System memory

### 1.7.1 Overview

The motherboard comes with four Double Data Rate 3 (DDR3) Dual Inline Memory Modules (DIMM) sockets.

A DDR3 module has the same physical dimensions as a DDR2 DIMM but is notched differently to prevent installation on a DDR2 DIMM socket. DDR3 modules are developed for better performance with less power consumption.

The figure illustrates the location of the DDR3 DIMM sockets:

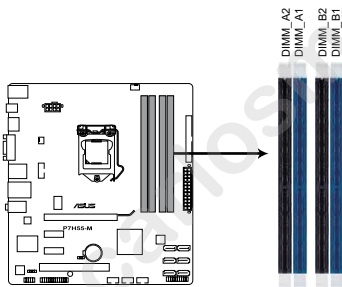

**P7H55-M 240-pin DDR3 DIMM sockets**

Channel	Sockets
Channel A	DIMM_A1 and DIMM_A2
Channel B	DIMM_B1 and DIMM_B2

## 1.7.2 Memory configurations

You may install 512MB, 1GB, 2GB, and 4GB unbuffered non-ECC DDR3 DIMMs into the DIMM sockets.



- 
- You may install varying memory sizes in Channel A and Channel B. The system maps the total size of the lower-sized channel for the dual-channel configuration. Any excess memory from the higher-sized channel is then mapped for single-channel operation.
  - Due to Intel spec definition, X.M.P. DIMMs are supported for one DIMM per channel only.
  - According to Intel CPU spec, DIMM voltage below 1.65V is recommended to protect the CPU.
  - According to Intel CPU spec, CPUs with a core frequency of 2.66GHz support the maximum DIMM frequency of up to DDR3 1333. To use DIMMs of a higher frequency with a 2.66GHz CPU, enable the **DRAM O.C. Profile** feature in BIOS. Refer to section **2.4.1 Ai Overclock Tuner** for details.
  - Always install DIMMs with the same CAS latency. For optimum compatibility, we recommend that you obtain memory modules from the same vendor.
  - Due to the memory address limitation on 32-bit Windows® OS, when you install 4GB or more memory on the motherboard, the actual usable memory for the OS can be about 3GB or less. For effective use of memory, we recommend that you do any of the following:
    - Use a maximum of 3GB system memory if you are using a 32-bit Windows® OS.
    - Install a 64-bit Windows® OS when you want to install 4GB or more on the motherboard.
  - This motherboard does not support DIMMs made up of 512Mb (64MB) chips or less.
- 



- 
- The default memory operation frequency is dependent on its Serial Presence Detect (SPD), which is the standard way of accessing information from a memory module. Under the default state, some memory modules for overclocking may operate at a lower frequency than the vendor-marked value. To operate at the vendor-marked or at a higher frequency, refer to section **Ai Tweaker menu** for manual memory frequency adjustment.
  - For system stability, use a more efficient memory cooling system to support a full memory load (4 DIMMs) or overclocking condition.
- 



- 
- ASUS exclusively provides hyper DIMM support function.
  - Hyper DIMM support is subject to the physical characteristics of individual CPUs.
  - According to Intel spec definition, DDR3 1600+ is supported for one DIMM per channel only. ASUS exclusively provides two DDR3 1600+ DIMM support for each memory channel.
  - Visit the ASUS website at [www.asus.com](http://www.asus.com) for the latest QVL.
-

## P7H55-M Motherboard Qualified Vendors Lists (QVL)

### DDR3-2200(O.C.) MHz capability for Lynnfield CPU (2.8 GHz & 2.93 GHz)

Vendor	Part No.	Size	SS/DS	Chip Brand	Chip NO.	Timing	Voltage	DIMM socket support (Optional)		
								A*	B*	C*
G.SKILL	F3-17600CL8D-4GBPS(XMP)	4096MB(Kit of 2)	DS	-	-	8-8-8-24	1.65V	*	*	*
Kingmax	FLKE85F-B8KJA FEIH(XMP)	2048MB	DS	-	-	-	-	*	*	*

### DDR3-2133 MHz capability for Lynnfield CPU (2.8 GHz & 2.93 GHz)

Vendor	Part No.	Size	SS/DS	Chip Brand	Chip NO.	Timing	Voltage	DIMM socket support (Optional)		
								A*	B*	C*
G.SKILL	F3-17066CL8D-4GBPS(XMP)	4096MB(Kit of 2)	DS	-	-	8-8-8-24	1.65V	*	*	*
GEIL	GU34GB2133C9DC(XMP)	4096MB(Kit of 2)	DS	-	-	9-9-9-28	1.65V	*	*	*
KINGSTON	KHX2133C8D3T1K2/4GX(XMP)	4096MB(Kit of 2)	DS	-	-	-	1.65V	*	*	*
KINGSTON	KHX2133C9D3T1K2/4GX(XMP)	4096MB(Kit of 2)	DS	-	-	-	1.65V	*	*	*

### DDR3-2000 MHz capability for Lynnfield CPU (2.8 GHz & 2.93 GHz)

Vendor	Part No.	Size	SS/DS	Chip Brand	Chip NO.	Timing	Voltage	DIMM socket support (Optional)		
								A*	B*	C*
CORSAIR	CMG4GX3M2A2000C8(XMP)	4096MB(Kit of 2)	DS	-	-	8-8-8-24	1.65V	*	*	*
G.SKILL	F3-16000CL9D-4GBTD(XMP)	4096MB(Kit of 2)	DS	-	-	9-9-9-27	1.65V	*	*	*
KINGSTON	KHX2000C8D3T1K3/3GX(XMP)	3072MB(Kit of 3)	SS	-	-	-	1.65V	*	*	*
KINGSTON	KHX2000C9D3T1K3/3GX(XMP)	3072MB(Kit of 3)	SS	-	-	-	1.65V	*	*	*
KINGSTON	KHX2000C8D3T1K3/6GX(XMP)	6144MB(Kit of 3)	DS	-	-	-	1.65V	*	*	*
OCZ	OCZ3P20002GK(EPP)	2048MB(Kit of 2)	SS	-	-	9-9-9-30	1.85V	*	*	*
OCZ	OCZ3P2000EB2GK	2048MB(Kit of 2)	SS	-	-	9-8-8-30	1.8V	*	*	*
OCZ	OCZ3P20004GK(EPP)	4096MB(Kit of 2)	DS	-	-	9-9-9-30	1.9V	*	*	*
PATRIOT	PVT36G2000LLK	6144MB(Kit of 3)	DS	-	-	8-8-8-24	1.65V	*	*	*

### DDR3-1866 MHz capability for Lynnfield CPU (2.8 GHz & 2.93 GHz)

Vendor	Part No.	Size	SS/DS	Chip Brand	Chip NO.	Timing	Voltage	DIMM socket support (Optional)		
								A*	B*	C*
KINGSTON	KHX1866C9D3T1K3/6GX(XMP)	6144MB(Kit of 3)	DS	-	-	-	1.65V	*	*	*
OCZ	OCZ3P1866LV4GK	4096MB(Kit of 2)	DS	-	-	9-9-9-27	1.65V	*	*	*
OCZ	OCZ3P1866C9LV6GK	6144MB(Kit of 3)	DS	-	-	9-9-9-28	1.65V	*	*	*

### DDR3-1800 MHz capability for Lynnfield CPU (2.8 GHz & 2.93 GHz)

Vendor	Part No.	Size	SS/DS	Chip Brand	Chip NO.	Timing	Voltage	DIMM socket support (Optional)		
								A*	B*	C*
OCZ	OCZ3G18002GK	2048MB(Kit of 2)	SS	-	-	9-9-9-27	1.9V	*	*	*
OCZ	OCZ3P18004GK	4096MB(Kit of 2)	DS	-	-	8-8-8-27	1.9V	*	*	*
OCZ	OCZ3P18004GK	4096MB(Kit of 2)	DS	-	-	8-8-8-27	1.9V	*	*	*

## DDR3-1600 MHz capability for Lynnfield CPU (2.66 GHz)

Vendor	Part No.	Size	SS/DS	Chip Brand	Chip NO.	Timing	Voltage	DIMM socket support (Optional)		
								A*	B*	C*
A-Data	AD31600X002GMU(XMP)	4096MB(Kit of 2)	DS	-	-	7-7-7-20	1.75-1.85V	*	*	*
CORSAIR	TR3X6G1600C8D G(XMP)	6144MB(Kit of 3)	DS	-	-	8-8-8-24	1.65V	*	*	*
CORSAIR	TR3X6G1600C8D G(XMP)	6144MB(Kit of 3)	DS	-	-	8-8-8-24	1.65V	*	*	*
G.Skill	F3-12800CL8T-6GBP(XMP)	6144MB(Kit of 3)	DS	-	-	8-8-8-21	1.6-1.65V	*	*	*
G.SKILL	F3-12800CL9T-6GBN(XMP)	6144MB(Kit of 3)	DS	-	-	9-9-9-24	1.5V-1.6V	*	*	*

## DDR3-1600 MHz capability for Lynnfield CPU (2.8 GHz & 2.93 GHz)

Vendor	Part No.	Size	SS/DS	Chip Brand	Chip NO.	Timing	Voltage	DIMM socket support (Optional)		
								A*	B*	C*
A-Data	AD31600E001GM(O)U3K	3072MB(Kit of 3)	SS	-	-	8-8-8-24	1.65V-1.85V	*	*	*
A-Data	AD31600X002GMU(XMP)	4096MB(Kit of 2)	DS	-	-	7-7-7-20	1.75-1.85V	*	*	*
CORSAIR	TR3X3G1600C8D(XMP)	3072MB(Kit of 3)	SS	-	-	8-8-8-24	1.65V	*	*	*
CORSAIR	CMX4GX3M2A1600C9(XMP)	4096MB(Kit of 2)	DS	-	-	9-9-9-24	1.65V	*	*	*
CORSAIR	TR3X6G1600C8D G(XMP)	6144MB(Kit of 3)	DS	-	-	8-8-8-24	1.65V	*	*	*
CORSAIR	TR3X6G1600C8D G(XMP)	6144MB(Kit of 3)	DS	-	-	8-8-8-24	1.65V	*	*	*
Crucial	BL12864BA1608.8SFB(XMP)	3072MB(Kit of 3)	SS	-	-	8-8-8-24	1.8V	*	*	*
Crucial	BL12864BE2009.8SFB3(EPP)	3072MB(Kit of 3)	SS	-	-	9-9-9-28	2.0V	*	*	*
Crucial	BL25664TG1608.K16SF(XMP)	6144MB(Kit of 3)	DS	-	-	8-8-8-24	-	*	*	*
Crucial	BL25664TR1608.K16SF(XMP)	6144MB(Kit of 3)	DS	-	-	8-8-8-24	-	*	*	*
G.Skill	F3-12800CL8T-6GBP(XMP)	6144MB(Kit of 3)	DS	-	-	8-8-8-21	1.6-1.65V	*	*	*
G.SKILL	F3-12800CL9T-6GBN(XMP)	6144MB(Kit of 3)	DS	-	-	9-9-9-24	1.5V-1.6V	*	*	*
Kingmax	FLGE85F-B8MF7 MEEH(XMP)	2048MB	DS	-	-	7	-	*	*	*
KINGSTON	KHX1600C8D3T1K2/4GX(XMP)	4096MB(Kit of 2)	DS	-	-	-	1.65V	*	*	*
KINGSTON	KHX1600C9D3K3/6GX(XMP)	6144MB(Kit of 3)	DS	-	-	-	1.65V	*	*	*
OCZ	OCZ3OB1600LV4GK	4096MB(Kit of 2)	DS	-	-	-	1.65V	*	*	*
OCZ	OCZ3X16004GK(XMP)	4096MB(Kit of 2)	DS	-	-	7-7-7-24	1.9V	*	*	*
Super Talent	WA160UX6G9	6144MB(Kit of 3)	DS	-	-	9	-	*	*	*

## DDR3-1333 MHz capability for Lynnfield CPU (2.66 GHz, 2.8 GHz, & 2.93 GHz)

Vendor	Part No.	Size	SS/ DS	Chip Brand	Chip NO.	Timing	Voltage	DIMM socket support (Optional)		
								A*	B*	C*
A-Data	AD31333G001GOU	3072MB (Kit of 3)	SS	-	-	8-8-8-24	1.65-1.85V	*	*	*
A-Data	AD31333G002GMU	2048MB	DS	-	-	8-8-8-24	1.65-1.85V	*	*	*
Apacer	78.A1GC6.9L1	2048MB	DS	APACER	AMS5808DEWSBG	-	-	*	*	*
CORSAIR	CM3X1024-1333C9	1024MB	SS	-	-	9-9-9-24	1.60V	*	*	*
CORSAIR	TR3X3G1333C9 G	3072MB (Kit of 3)	SS	-	-	9-9-9-24	1.50V	*	*	*
CORSAIR	TR3X3G1333C9 G	3072MB (Kit of 3)	SS	-	-	9-9-9-24	1.50V	*	*	*
CORSAIR	CMX8GX3M4A1333C9	8192MB (Kit of 4)	DS	-	-	9-9-9-24	1.50V	*	*	*
Crucial	CT12864BA1339.8FF	1024MB	SS	Micron	9FF22D9KPT	9	-	*	*	*
Crucial	CT25664BA1339.16FF	2048MB	DS	Micron	9KF27D9KPT	9	-	*	*	*
G.SKILL	F3-10600CL8D-2GBHK	1024MB	SS	G.SKILL	-	-	-	*	*	*
G.SKILL	F3-10600CL9D-2GBPK	1024MB	SS	G.SKILL	-	-	-	*	*	*
G.SKILL	F3-10666CL8D-4GBECO(XMP)	4096MB (Kit of 2)	DS	-	-	8-8-8-24	1.35V(low voltage)	*	*	*
G.SKILL	F3-10666CL8D-4GBHK(XMP)	4096MB (Kit of 2)	DS	-	-	8-8-8-21	1.5-1.6V	*	*	*
GEIL	GG34GB1333C9DC	4096MB (Kit of 2)	DS	GEIL	GL1L128M88BA12N	9-9-9-24	1.3V(low voltage)	*	*	*
Kingmax	FLFD45F-B8MF9	1024MB	SS	Micron	8HD22D9JNM	-	-	*	*	*
KINGSTON	KVR1333D3N9/1G	1024MB	SS	KTC	D1288JELDPG09U	-	-	*	*	*
KINGSTON	KVR1333D3N9/2G	2048MB	DS	Qimonda	IDSH1G-03A1F1C-13H	-	1.5V	*	*	*
KINGSTON	KVR1333D3N9/4G	4096MB	DS	Hynix	H5TQ2G83AFR	-	-	*	*	*
Micron	MT8JTF12864AZ-1G4F1	1024MB	SS	Micron	9FF22D9KPT	9	-	*	*	*
Micron	MT16JTF25664AZ-1G4F1	2048MB	DS	Micron	9KF27D9KPT	9	-	*	*	*
OCZ	OCZ3P13332GK	2048MB (Kit of 2)	SS	-	-	7-7-7-20	1.8V	*	*	*
OCZ	OCZ3X13334GK(XMP)	4096MB (Kit of 2)	DS	-	-	7-7-7-20	1.75V	*	*	*
PSC	AL7F8G73D-DG1	1024MB	SS	PSC	A3P1GF3DGF928M9B05	8-8-8-24	1.5V	*	*	*
PSC	AL8F8G73D-DG1	2048MB	DS	PSC	A3P1GF3DGF928M9B05	8-8-8-24	1.5V	*	*	*
SAMSUNG	M378B2873EH1-CH9	1024MB	SS	Samsung	SEC 913 HCH9 K4B1G0846E	-	-	*	*	*
SAMSUNG	M378B5673DZ1-CH9	2048MB	DS	Samsung	K4B1G0846D-HCH9	-	-	*	*	*
Transcend	TS256MLK64V3U	2048MB	DS	Micron	9GF27D9KPT	-	-	*	*	*



### SS: Single-sided / DS: Double-sided

#### DIMM support:

- **A\***: Supports one module inserted into any slot as single-channel memory configuration.
- **B\***: Supports one pair of modules inserted into either the blue slots or the black slots as one pair of dual-channel memory configuration.
- **C\***: Supports two pairs of modules inserted into both the blue slots and the black slots as two pairs of dual-channel memory configuration.



- The QVL for the Clarkdale CPU is not included in this manual. You can get it from the ASUS website at [www.asus.com](http://www.asus.com)
- Visit the ASUS website at [www.asus.com](http://www.asus.com) for the latest QVL.

## 1.7.3 Installing a DIMM



Ensure to unplug the power supply before adding or removing DIMMs or other system components. Failure to do so may cause severe damage to both the motherboard and the components.

To install a DIMM

1. Unlock a DIMM socket by pressing the retaining clip outward.
2. Align a DIMM on the socket such that the notch on the DIMM matches the DIMM slot key on the socket.

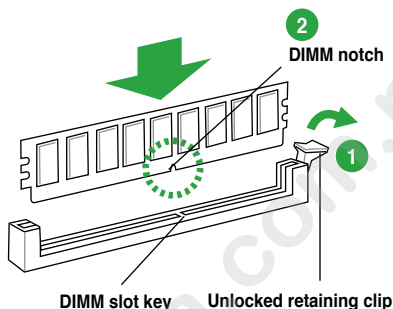

A DIMM is keyed with a notch so that it fits in only one direction. DO NOT force a DIMM into a socket in the wrong direction to avoid damaging the DIMM.

3. Firmly insert the DIMM into the socket until the retaining clip snaps back in place and the DIMM is properly seated.

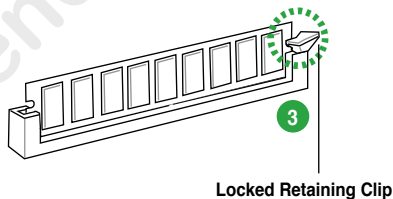

## 1.7.4 Removing a DIMM

Follow these steps to remove a DIMM.

1. Press the retaining clip outward to unlock the DIMM.



Support the DIMM lightly with your fingers when pressing the retaining clip. The DIMM might get damaged when it flips out with extra force.

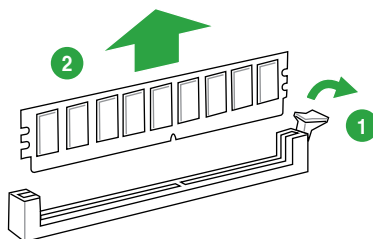

2. Remove the DIMM from the socket.

## 1.8 Expansion slots

In the future, you may need to install expansion cards. The following sub-sections describe the slots and the expansion cards that they support.



---

Unplug the power cord before adding or removing expansion cards. Failure to do so may cause you physical injury and damage motherboard components.

---

### 1.8.1 Installing an expansion card

To install an expansion card:

1. Before installing the expansion card, read the documentation that came with it and make the necessary hardware settings for the card.
2. Remove the system unit cover (if your motherboard is already installed in a chassis).
3. Remove the bracket opposite the slot that you intend to use. Keep the screw for later use.
4. Align the card connector with the slot and press firmly until the card is completely seated on the slot.
5. Secure the card to the chassis with the screw you removed earlier.
6. Replace the system cover.

### 1.8.2 Configuring an expansion card

After installing the expansion card, configure it by adjusting the software settings.

1. Turn on the system and change the necessary BIOS settings, if any. See Chapter 2 for information on BIOS setup.
2. Assign an IRQ to the card.
3. Install the software drivers for the expansion card.



---

When using PCI cards on shared slots, ensure that the drivers support "Share IRQ" or that the cards do not need IRQ assignments. Otherwise, conflicts will arise between the two PCI groups, making the system unstable and the card inoperable.

---

### 1.8.3 PCI slot

The PCI slot supports cards such as a LAN card, SCSI card, USB card, and other cards that comply with PCI specifications.

### 1.8.4 PCI Express x1 slots

This motherboard supports PCI Express x1 network cards, SCSI cards, and other cards that comply with the PCI Express specifications.

### 1.8.5 PCI Express x16 slot

This motherboard has a PCI Express 2.0 x16 slot that supports PCI Express x16 2.0 graphic cards complying with the PCI Express specifications.

# 1.9 Jumpers

## 1. Clear RTC RAM (3-pin CLRTC)

This jumper allows you to clear the Real Time Clock (RTC) RAM in CMOS. You can clear the CMOS memory of date, time, and system setup parameters by erasing the CMOS RTC RAM data. The onboard button cell battery powers the RAM data in CMOS, which include system setup information such as system passwords.

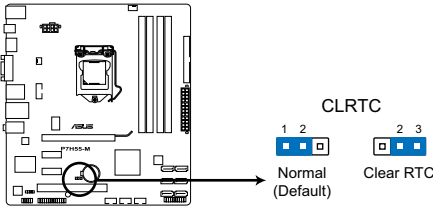

**P7H55-M Clear RTC RAM**

To erase the RTC RAM:

1. Turn OFF the computer and unplug the power cord.
2. Move the jumper cap from pins 1-2 (default) to pins 2-3. Keep the cap on pins 2-3 for about 5-10 seconds, then move the cap back to pins 1-2.
3. Plug the power cord and turn ON the computer.
4. Hold down the **<Del>** key during the boot process and enter BIOS setup to re-enter data.



Except when clearing the RTC RAM, never remove the cap on CLRTC jumper default position. Removing the cap will cause system boot failure!



- If the steps above do not help, remove the onboard battery and move the jumper again to clear the CMOS RTC RAM data. After clearing the CMOS, reinstall the battery.
- You do not need to clear the RTC when the system hangs due to overclocking. For system failure due to overclocking, use the CPU Parameter Recall (C.P.R.) feature. Shut down and reboot the system, then the BIOS automatically resets parameter settings to default values.
- Due to the chipset limitation, AC power off is required before you use the C.P.R. function. You must turn off and on the power supply or unplug and plug the power cord before rebooting the system.



# 1.10 Connectors

## 1.10.1 Rear panel connectors

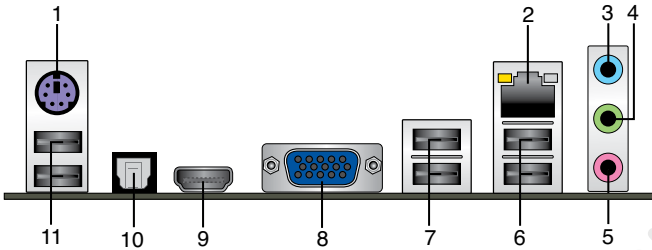

- PS/2 Keyboard/Mouse Combo port (purple).** This port is for a PS/2 keyboard or PS/2 mouse.
- LAN (RJ-45) port.** This port allows Gigabit connection to a Local Area Network (LAN) through a network hub. Refer to the table below for the LAN port LED indications.

### LAN port LED indications

Activity Link LED		Speed LED	
Status	Description	Status	Description
OFF	No link	OFF	10 Mbps connection
BLINKING	Data activity	ORANGE	100 Mbps connection
		GREEN	1 Gbps connection

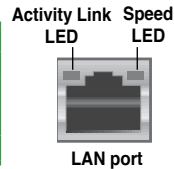

- Line In port (light blue).** This port connects to the tape, CD, DVD player, or other audio sources.
- Line Out port (lime).** This port connects to a headphone or a speaker. In the 4, 6, and 8-channel configurations, the function of this port becomes Front Speaker Out.
- Microphone port (pink).** This port connects to a microphone.



Refer to the audio configuration table below for the function of the audio ports in a 2, 4, 6, or 8-channel configuration.

### Audio 2, 4, 6, or 8-channel configuration

Port	Headset 2-channel	4-channel	6-channel	8-channel
Light Blue (Rear panel)	Line In	Rear Speaker Out	Rear Speaker Out	Rear Speaker Out
Lime (Rear panel)	Line Out	Front Speaker Out	Front Speaker Out	Front Speaker Out
Pink (Rear panel)	Mic In	Mic In	Bass/Center	Bass/Center
Lime (Front panel)	-	-	-	Side Speaker Out



### To configure an 8-channel audio output:

Use a chassis with HD audio module in the front panel to support an 8-channel audio output.

6. **USB 2.0 ports 1 and 2.** These two 4-pin Universal Serial Bus (USB) ports are available for connecting USB 2.0 devices.
7. **USB 2.0 ports 3 and 4.** These two 4-pin Universal Serial Bus (USB) ports are available for connecting USB 2.0 devices.
8. **VGA port.** This 15-pin port is for a VGA monitor or other VGA-compatible devices.
9. **HDMI port.** This port is for a High-Definition Multimedia Interface (HDMI) connector, and is HDCP compliant allowing playback of HD DVD, Blu-ray, and other protected content.
10. **Optical S/PDIF Out port.** This port connects an external audio output device via an optical S/PDIF cable.
11. **USB 2.0 ports 5 and 6.** These two 4-pin Universal Serial Bus (USB) ports are available for connecting USB 2.0 devices.

## 1.10.2 Internal connectors

### 1. Front panel audio connector (10-1 pin AAFP)

This connector is for a chassis-mounted front panel audio I/O module that supports either HD Audio or legacy AC'97 audio standard. Connect one end of the front panel audio I/O module cable to this connector.

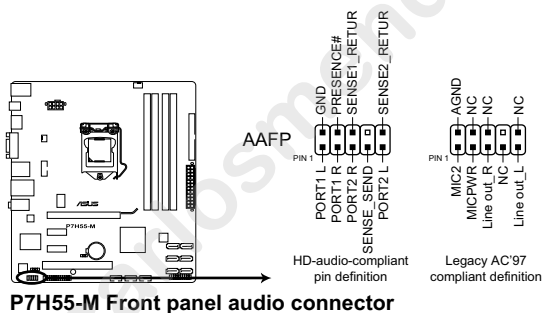

- We recommend that you connect a high-definition front panel audio module to this connector to avail of the motherboard's high-definition audio capability.
- If you want to connect a high-definition front panel audio module to this connector, set the **Front Panel Type** item in the BIOS setup to **[HD Audio]**. If you want to connect an AC'97 front panel audio module to this connector, set the item to **[AC97]**. By default, this connector is set to **[HD Audio]**. See section **2.5.3 Onboard Devices Configuration** for details.

## 2. IDE connector (40-1 pin PRI\_EIDE)

The onboard IDE connector is for the Ultra DMA 133/100 signal cable. There are three connectors on each Ultra DMA 133/100 signal cable: blue, black, and gray. Connect the blue connector to the motherboard's IDE connector, then select one of the following modes to configure your device.

	Drive jumper setting	Mode of device(s)	Cable connector
Single device	Cable-Select or Master	-	Black
Two devices	Cable-Select	Master	Black
		Slave	Gray
	Master	Master	Black or gray
		Slave	



- Pin 20 on the IDE connector is removed to match the covered hole on the Ultra DMA cable connector. This prevents incorrect insertion when you connect the IDE cable.
- Use the 80-conductor IDE cable for Ultra DMA 133/100 IDE devices.

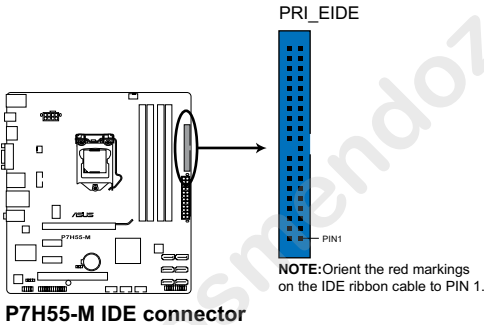

**P7H55-M IDE connector**



If any device jumper is set as "Cable-Select," ensure that all other device jumpers have the same setting.

## 3. LPT connector (26-1 pin LPT)

The LPT (Line Printing Terminal) connector supports devices such as a printer. LPT is standardized as IEEE 1284, which is the parallel port interface on IBM PC-compatible computers.

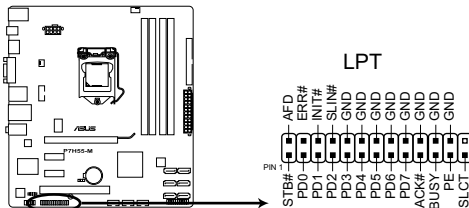

**P7H55-M Parallel port connector**

#### 4. ATX power connectors (24-pin EATXPWR, 8-pin ATX12V)

These connectors are for ATX power supply plugs. The power supply plugs are designed to fit these connectors in only one orientation. Find the proper orientation and push down firmly until the connectors completely fit.

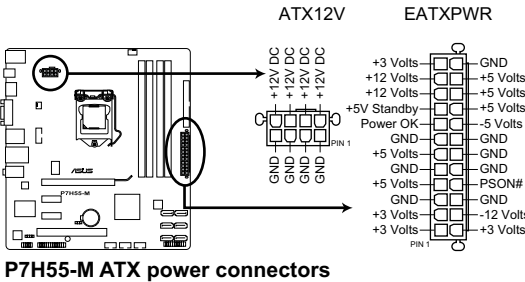

- For a fully configured system, we recommend that you use a power supply unit (PSU) that complies with ATX 12 V Specification 2.0 (or later version) and provides a minimum power of 400 W.
- DO NOT forget to connect the 4-pin / 8-pin ATX +12V power plug. Otherwise, the system will not boot up.
- We recommend that you use a PSU with higher power output when configuring a system with more power-consuming devices. The system may become unstable or may not boot up if the power is inadequate.
- If you are uncertain about the minimum power supply requirement for your system, refer to the Recommended Power Supply Wattage Calculator at <http://support.asus.com/PowerSupplyCalculator/PSCalculator.aspx?SLanguage=en-us> for details.

#### 5. Serial port connector (10-1 pin COM1)

This connector is for a serial (COM) port. Connect the serial port module cable to this connector, then install the module to a slot opening at the back of the system chassis.

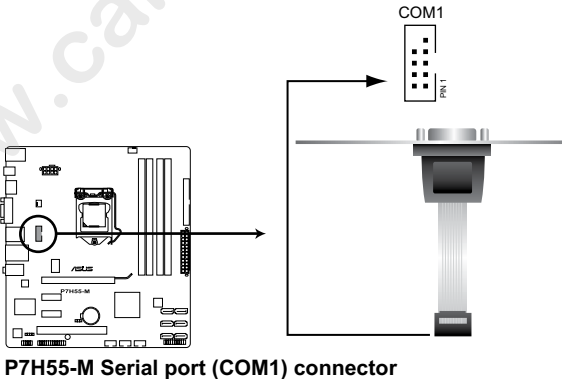

The COM module is purchased separately.

## 6. CPU and chassis fan connectors (4-pin CPU\_FAN, 3-pin CHA\_FAN1)

Connect the fan cables to the fan connectors on the motherboard, ensuring that the black wire of each cable matches the ground pin of the connector.

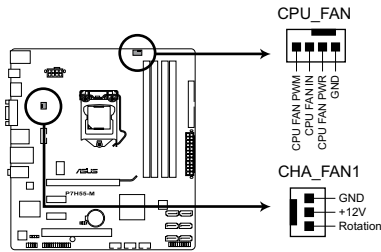

**P7H55-M fan connectors**



Do not forget to connect the fan cables to the fan connectors. Insufficient air flow inside the system may damage the motherboard components. These are not jumpers! Do not place jumper caps on the fan connectors!



- Only the 4-pin CPU fan supports the ASUS Q-FAN feature.
- The CPU\_FAN connector supports a CPU fan of maximum 2A (24 W) fan power.

## 7. Digital audio connector (4-1 pin SPDIF\_OUT)

This connector is for an additional Sony/Philips Digital Interface (S/PDIF) port. Connect the S/PDIF Out module cable to this connector, then install the module to a slot opening at the back of the system chassis.

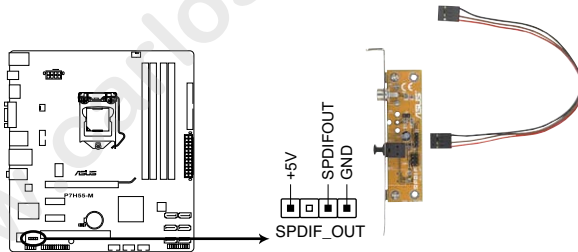

**P7H55-M Digital audio connector**



The S/PDIF module is purchased separately.

## 8. Serial ATA connectors (7-pin SATA1-6)

These connectors are for the Serial ATA signal cables for Serial ATA 3Gb/s hard disk and optical disk drives. The Serial ATA 3Gb/s is backward compatible with Serial ATA 1.5Gb/s specification. The data transfer rate of the Serial ATA 3Gb/s is faster than the standard parallel ATA with 133 MB/s (Ultra DMA133).

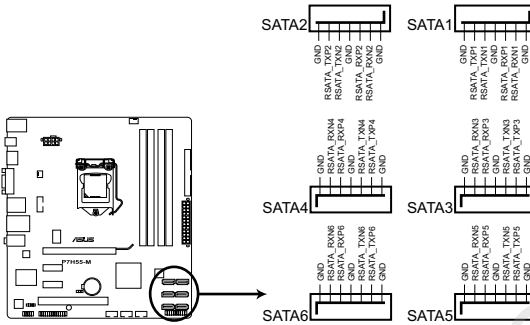

**P7H55-M SATA connectors**



Install the Windows® XP Service Pack 2 or later version before using Serial ATA.

## 9. USB connectors (10-1 pin USB78, USB910, USB1112)

These connectors are for USB 2.0 ports. Connect the USB module cable to any of these connectors, then install the module to a slot opening at the back of the system chassis. These USB connectors comply with USB 2.0 specification that supports up to 480 Mbps connection speed.

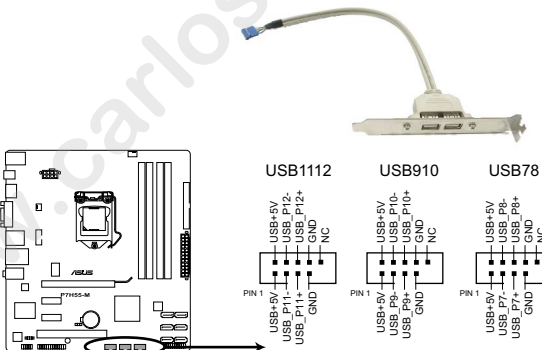

**P7H55-M USB2.0 connectors**



Never connect a 1394 cable to the USB connectors. Doing so will damage the motherboard!



The USB module cable is purchased separately.

## 10. System panel connector (20-8 pin PANEL)

This connector supports several chassis-mounted functions.

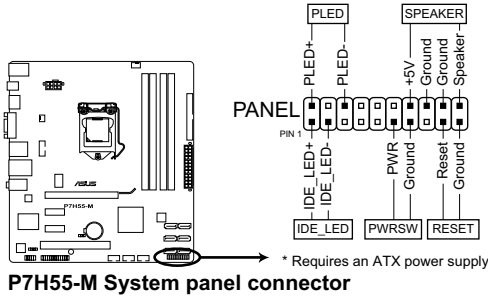

- **System power LED (2-pin PLED)**

This 2-pin connector is for the system power LED. Connect the chassis power LED cable to this connector. The system power LED lights up when you turn on the system power, and blinks when the system is in sleep mode.

- **Hard disk drive activity LED (2-pin IDE\_LED)**

This 2-pin connector is for the HDD Activity LED. Connect the HDD Activity LED cable to this connector. The IDE LED lights up or flashes when data is read from or written to the HDD.

- **System warning speaker (4-pin SPEAKER)**

This 4-pin connector is for the chassis-mounted system warning speaker. The speaker allows you to hear system beeps and warnings.

- **ATX power button/soft-off button (2-pin PWR SW)**

This 2-pin connector is for the system power button.

- **Reset button (2-pin RESET)**

This 2-pin connector is for the chassis-mounted reset button for system reboot without turning off the system power.

## 1.11 Software support

### 1.11.1 Installing an operating system

This motherboard supports Windows® XP / 64-bit XP / Vista / 64-bit Vista / 7 / 64-bit 7 Operating Systems (OS). Always install the latest OS version and corresponding updates to maximize the features of your hardware.



- Motherboard settings and hardware options vary. Refer to your OS documentation for detailed information.
- Ensure that you install Windows® XP Service Pack 3 or later versions / Windows® Vista Service Pack 1 or later versions before installing the drivers for better compatibility and system stability.

### 1.11.2 Support DVD information

The Support DVD that comes with the motherboard package contains the drivers, software applications, and utilities that you can install to avail all motherboard features.



The contents of the Support DVD are subject to change at any time without notice. Visit the ASUS website at [www.asus.com](http://www.asus.com) for updates.

### To run the Support DVD

Place the Support DVD to the optical drive. If Autorun is enabled in your computer, the DVD automatically displays the Specials screen which contains the unique feature of ASUS motherboard. Click Drivers, Utilities, Make Disk, Manual, and Contact tabs to display their respective menus.



The following screen is for reference only.

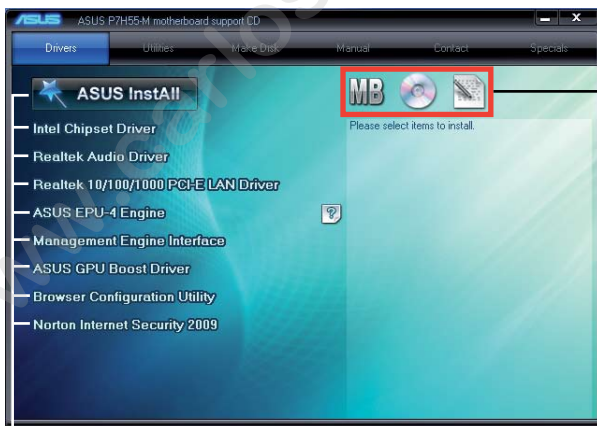

Click an icon to display Support DVD/  
motherboard information

Click an item to install



If Autorun is NOT enabled in your computer, browse the contents of the Support DVD to locate the file ASSETUP.EXE from the BIN folder. Double-click the ASSETUP.EXE to run the DVD.



# Chapter 2

## BIOS information

### 2.1 Managing and updating your BIOS



Save a copy of the original motherboard BIOS file to a USB flash disk in case you need to restore the BIOS in the future. Copy the original motherboard BIOS using the ASUS Update utility.

#### 2.1.1 ASUS Update utility

The ASUS Update is a utility that allows you to manage, save, and update the motherboard BIOS in Windows® environment.



- ASUS Update requires an Internet connection either through a network or an Internet Service Provider (ISP).
- This utility is available in the support DVD that comes with the motherboard package.

#### Installing ASUS Update

To install ASUS Update:

1. Place the support DVD in the optical drive. The **Drivers** menu appears.
2. Click the **Utilities** tab, then click **ASUS Update**.
3. Follow the onscreen instructions to complete the installation.



Quit all Windows® applications before you update the BIOS using this utility.

#### Updating the BIOS

To update the BIOS:

1. From the Windows® desktop, click **Start > Programs > ASUS > ASUSUpdate > ASUSUpdate** to launch the ASUS Update utility.
2. From the dropdown list, select any of the updating process:  
*Updating from the Internet*
  - a. Select **Update BIOS from the Internet**, then click **Next**.
  - b. Select the ASUS FTP site nearest you to avoid network traffic, or click **Auto Select** then click **Next**.
  - c. From the FTP site, select the BIOS version that you wish to download then click **Next**.



The ASUS Update utility is capable of updating itself through the Internet. Always update the utility to avail all its features.

#### Updating from a BIOS file

- a. Select **Update BIOS from a file**, then click **Next**.
  - b. Locate the BIOS file from the **Open** window, then click **Open**.
3. Follow the onscreen instructions to complete the updating process.

## 2.1.2 ASUS EZ Flash 2

The ASUS EZ Flash 2 feature allows you to update the BIOS without using an OS-based utility.



Before you start using this utility, download the latest BIOS file from the ASUS website at [www.asus.com](http://www.asus.com).

To update the BIOS using EZ Flash 2:

1. Insert the USB flash disk that contains the latest BIOS file to the USB port, then launch EZ Flash 2 in any of these two ways:
  - Press **<Alt> + <F2>** during POST.
  - Enter the BIOS setup program. Go to the **Tools** menu to select **EZ Flash 2** and press **<Enter>** to enable it.Press **<Tab>** to switch between drives until the correct BIOS file is found.

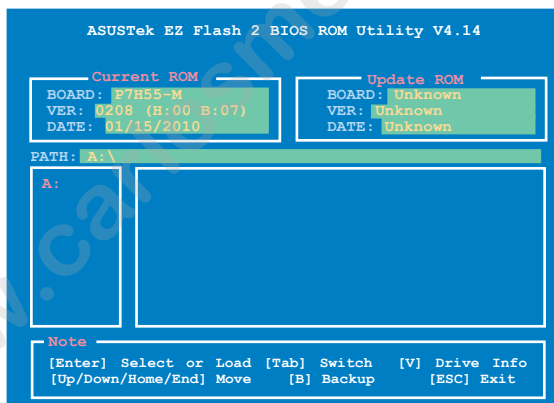

2. When the correct BIOS file is found, EZ Flash 2 performs the BIOS update process and automatically reboots the system when done.



- This function supports USB flash disks with **FAT 32/16** format and single partition only.
- **DO NOT** shut down or reset the system while updating the BIOS to prevent system boot failure!

### 2.1.3 ASUS CrashFree BIOS

The ASUS CrashFree BIOS is an auto recovery tool that allows you to restore the BIOS file when it fails or gets corrupted during the updating process. You can restore a corrupted BIOS file using the motherboard support DVD or a removable device that contains the updated BIOS file.



- Before using this utility, rename the BIOS file in the removable device into **P7H55MA.ROM**.
- The BIOS file in the support DVD may not be the latest version. Download the latest BIOS file from the ASUS website at [www.asus.com](http://www.asus.com).
- The removable devices that ASUS CrashFree BIOS support vary with motherboard models. For motherboards without the floppy connector, prepare a USB flash disk before using this utility.

### Recovering the BIOS

To recover the BIOS:

1. Turn on the system.
2. Insert the support DVD to the optical drive or the removable device that contains the BIOS file to the USB port or to the floppy disk drive, if supported.
3. The utility automatically checks the devices for the BIOS file. When found, the utility reads the BIOS file and starts flashing the corrupted BIOS file.
4. Turn off the system after the utility completes the updating process and turn on again.



DO NOT shut down or reset the system while updating the BIOS! Doing so can cause system boot failure!



Ensure to load the BIOS default settings to ensure system compatibility and stability. Select the **Load Setup Defaults** item under the Exit menu. Refer to section 2.9 **Exit menu** for details.

### 2.1.4 ASUS BIOS Updater

The ASUS BIOS Updater allows you to update BIOS in DOS environment. This utility also allows you to copy the current BIOS file that you can use as a backup when the BIOS fails or gets corrupted during the updating process.



The succeeding utility screens are for reference only. The actual utility screen displays may not be same as shown.

### Before updating BIOS

1. Prepare the motherboard support DVD and a USB flash drive in FAT32/16 format and single partition.
2. Download the latest BIOS file and BIOS Updater from the ASUS website at <http://support.asus.com> and save them on the USB flash drive.



- NTFS is not supported under DOS environment. Do not save the BIOS file and BIOS Updater to a hard disk drive or USB flash drive in NTFS format.
- Do not save the BIOS file to a floppy disk due to low disk capacity.

3. Turn off the computer and disconnect all SATA hard disk drives (optional).

### Booting the system in DOS environment

1. Insert the USB flash drive with the latest BIOS file and BIOS Updater to the USB port.
2. Boot your computer. When the ASUS Logo appears, press <F8> to show the **BIOS Boot Device Select Menu**. Insert the support DVD into the optical drive and select the optical drive as the boot device.

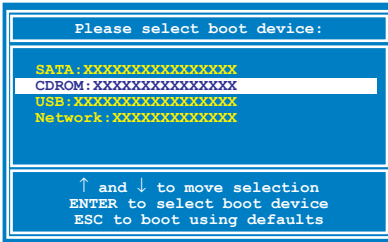

3. When the **Make Disk** menu appears, select the **FreeDOS command prompt** item by pressing the item number.
4. At the FreeDOS prompt, type `d:` and press <Enter> to switch the disk from Drive C (optical drive) to Drive D (USB flash drive).

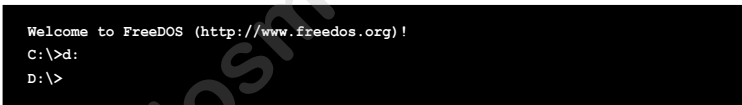

### Backing up the current BIOS

To backup the current BIOS file using the BIOS Updater



Ensure that the USB flash drive is not write-protected and has at least 1024KB free space to save the file.

1. At the FreeDOS prompt, type `bupdater /o[filename]` and press <Enter>.



The [filename] is any user-assigned filename with no more than eight alphanumeric characters for the filename and three alphanumeric characters for the extension.

2. The BIOS Updater backup screen appears indicating the BIOS backup process. When BIOS backup is done, press any key to return to the DOS prompt.

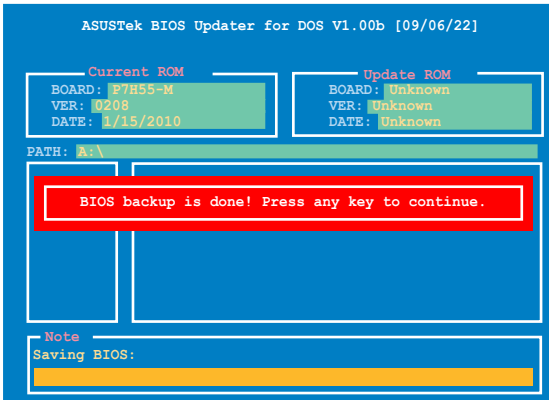

### Updating the BIOS file

To update the BIOS file using BIOS Updater

1. At the FreeDOS prompt, type `bupdater /pc /g` and press <Enter>.

```
D:\>bupdater /pc /g
```

2. The BIOS Updater screen appears as below.

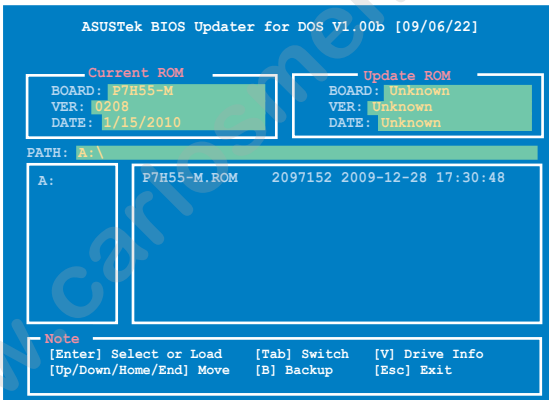

3. Press <Tab> to switch between screen fields and use the <Up/Down/Home/End> keys to select the BIOS file and press <Enter>. BIOS Updater checks the selected BIOS file and prompts you to confirm BIOS update.



4. Select Yes and press <Enter>. When BIOS update is done, press <ESC> to exit BIOS Updater. Restart your computer.



---

DO NOT shut down or reset the system while updating the BIOS to prevent system boot failure!

---



- For BIOS Updater version 1.04 or later, the utility automatically exits to the DOS prompt after updating BIOS.
  - Ensure to load the BIOS default settings to ensure system compatibility and stability. Select the **Load Setup Defaults** item under the Exit menu. Refer to section 2.9 **Exit menu** for details.
  - Ensure to connect all SATA hard disk drives after updating the BIOS file if you have disconnected them.
- 

## 2.2 BIOS setup program

Use the BIOS Setup program to update the BIOS or configure its parameters. The BIOS screens include navigation keys and brief online help to guide you in using the BIOS Setup program.

### Entering BIOS Setup at startup

To enter BIOS Setup at startup:

- Press <Delete> during the Power-On Self Test (POST). If you do not press <Delete>, POST continues with its routines.

### Entering BIOS Setup after POST

To enter BIOS Setup after POST:

- Press <Ctrl>+<Alt>+<Del> simultaneously.
- Press the reset button on the system chassis.
- Press the power button to turn the system off then back on. Do this option only if you failed to enter BIOS Setup using the first two options.



---

Using the **power button**, **reset button**, or the <Ctrl>+<Alt>+<Del> keys to force reset from a running operating system can cause damage to your data or system. We recommend to always shut down the system properly from the operating system.

---



- The default BIOS settings for this motherboard apply for most conditions to ensure optimum performance. If the system becomes unstable after changing any BIOS settings, load the default settings to ensure system compatibility and stability. Select the **Load Setup Defaults** item under the Exit Menu. See section 2.9 **Exit Menu**.
  - The BIOS setup screens shown in this section are for reference purposes only, and may not exactly match what you see on your screen.
  - Visit the ASUS website at [www.asus.com](http://www.asus.com) to download the latest BIOS file for this motherboard.
-

## 2.2.1 BIOS menu screen

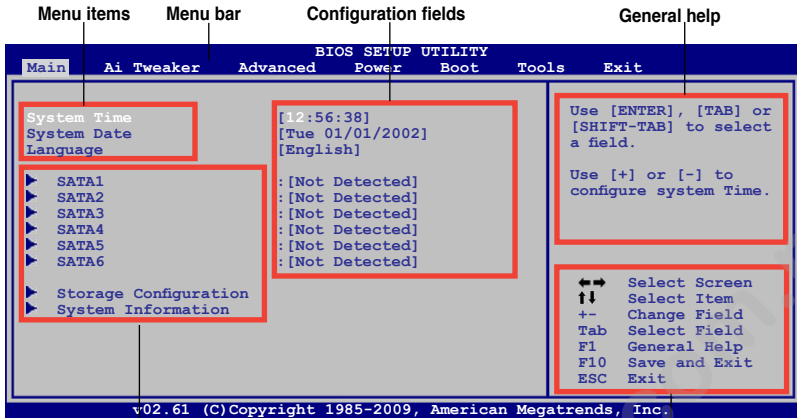

## 2.2.2 Menu bar

The menu bar on top of the screen has the following main items:

- Main** For changing the basic system configuration.
- Ai Tweaker** For changing system performance settings
- Advanced** For changing the advanced system settings.
- Power** For changing the advanced power management (APM) configuration.
- Boot** For changing the system boot configuration.
- Tools** For configuring options for special functions.
- Exit** For selecting the exit options and loading default settings.

To select an item on the menu bar, press the right or left arrow key on the keyboard until the desired item is highlighted.

## 2.2.3 Navigation keys

At the bottom right corner of a menu screen are the navigation keys for that particular menu. Use the navigation keys to select items in the menu and change the settings.



---

Some of the navigation keys differ from one screen to another.

---

## 2.2.4 Menu items

The highlighted item on the menu bar displays the specific items for that menu. For example, selecting Main shows the Main menu items.

The other items (Ai Tweaker, Advanced, Power, Boot, Tools, and Exit) on the menu bar have their respective menu items.

## 2.2.5 Submenu items

A solid triangle before each item on any menu screen means that the item has a submenu. To display the submenu, select the item and press **<Enter>**.

## 2.2.6 Configuration fields

These fields show the values for the menu items. If an item is user-configurable, you can change the value of the field opposite the item. You cannot select an item that is not user-configurable. A configurable field is enclosed in brackets, and is highlighted when selected. To change the value of a field, select it then press **<Enter>** to display a list of options. Refer to **2.2.7 Pop-up window**.

## 2.2.7 Pop-up window

Select a menu item then press **<Enter>** to display a pop-up window with the configuration options for that item.

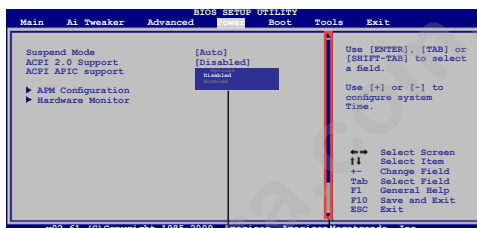

Pop-up window

Scroll bar

## 2.2.8 Scroll bar

A scroll bar appears on the right side of a menu screen when there are items that do not fit on the screen. Press the **<Up>** / **<Down>** arrow keys or **<Page Up>** / **<Page Down>** keys to display the other items on the screen.

## 2.2.9 General help

At the top right corner of the menu screen is a brief description of the selected item.

## 2.3 Main menu

When you enter the BIOS Setup program, the **Main** menu screen appears, giving you an overview of the basic system information.

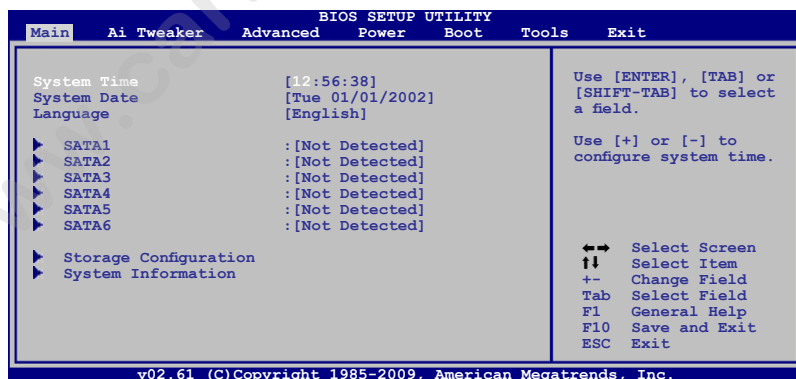



### 2.3.1 System Time [xx:xx:xx]

Allows you to set the system time.

### 2.3.2 System Date [Day xx/xx/xxxx]

Allows you to set the system date.

### 2.3.3 Language [English]

Allows you to choose the BIOS language version from the options. Configuration options: [Chinese (Trad.)] [Chinese (Simp.)] [Japanese] [French] [Deutsch] [English]

### 2.3.4 SATA1~6

While entering Setup, the BIOS automatically detects the presence of SATA devices. There is a separate submenu for each SATA device. Select a device item then press <Enter> to display the SATA device information.

The BIOS automatically detects the values opposite the dimmed items (Device, Vendor, Size, LBA Mode, Block Mode, PIO Mode, Async DMA, Ultra DMA, and SMART monitoring). These values are not user-configurable. These items show Not Detected if no SATA device is installed in the system.

#### Type [Auto]

Selects the type of SATA drive. Setting to [Auto] allows automatic selection of the appropriate SATA device type. Select [CDROM] if you are specifically configuring a CD-ROM drive. Select [ARMD] (ATAPI Removable Media Device) if your device is either a ZIP, LS-120, or MO drive. Configuration options: [Not Installed] [Auto] [CDROM] [ARMD]



---

This item only appears in the SATA1~4 menus.

---

#### LBA/Large Mode [Auto]

Enables or disables the LBA mode. Setting to [Auto] enables the LBA mode if the device supports this mode, and if the device was not previously formatted with LBA mode disabled. Configuration options: [Disabled] [Auto]

#### Block (Multi-Sector Transfer) M [Auto]

Enables or disables data multi-sectors transfers. When set to [Auto], the data transfer from and to the device occurs multiple sectors at a time if the device supports multi-sector transfer feature. When set to [Disabled], the data transfer from and to the device occurs one sector at a time. Configuration options: [Disabled] [Auto]

#### PIO Mode [Auto]

Selects the PIO mode. Configuration options: [Auto] [0] [1] [2] [3] [4]

#### DMA Mode [Auto]

Selects the DMA mode. Configuration options: [Auto]

#### SMART Monitoring [Auto]

Sets the Smart Monitoring, Analysis, and Reporting Technology. Configuration options: [Auto] [Disabled] [Enabled]

#### 32Bit Data Transfer [Enabled]

Enables or disables 32-bit data transfer. Configuration options: [Disabled] [Enabled]

### 2.3.5 Storage Configuration

The **Storage Configuration** menu allows you to configure your storage device(s). Select an item then press <Enter> to display the sub-menu.

#### SATA Configuration [Enhanced]

Configuration options: [Disabled] [Compatible] [Enhanced]

*Configure SATA as [IDE]*

Sets the configuration for the Serial ATA connectors supported by the Southbridge chip.

Configuration options: [IDE] [AHCI]



- If you want to use the Serial ATA hard disk drives as Parallel ATA physical storage devices, keep the default setting [IDE].
- If you want the Serial ATA hard disk drives to use the Advanced Host Controller Interface (AHCI), set this item to [AHCI]. The AHCI allows the onboard storage driver to enable advanced Serial ATA features that increases storage performance on random workloads by allowing the drive to internally optimize the order of commands.

#### Hard Disk Write Protect [Disabled]

Disables or enables device write protection. This will be effective only if the device is accessed through BIOS. Configuration option: [Disabled] [Enabled]

#### IDE Detect Time Out (Sec) [35]

Selects the time out value for detecting ATA/ATAPI devices. Configuration options: [0] [5] [10] [15] [20] [25] [30] [35]

### 2.3.6 System Information

This menu gives you an overview of the general system specifications. The BIOS automatically detects the items in this menu.

#### BIOS Information

Displays the auto-detected BIOS information

#### Processor

Displays the auto-detected CPU specification

#### System Memory

Displays the auto-detected system memory

## 2.4 Ai Tweaker menu

The Ai Tweaker menu items allow you to configure overclocking-related items.



Be cautious when changing the settings of the Ai Tweaker menu items. Incorrect field values can cause the system to malfunction.



The configuration options for this chapter vary depending on the CPU and DIMM model you installed on the motherboard.

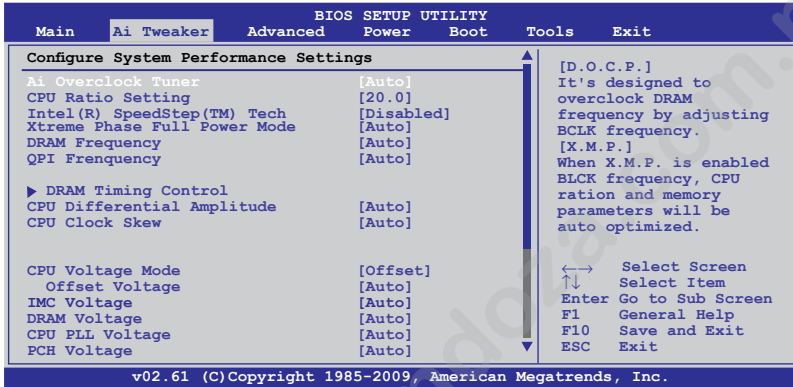

Scroll down to display the following items:

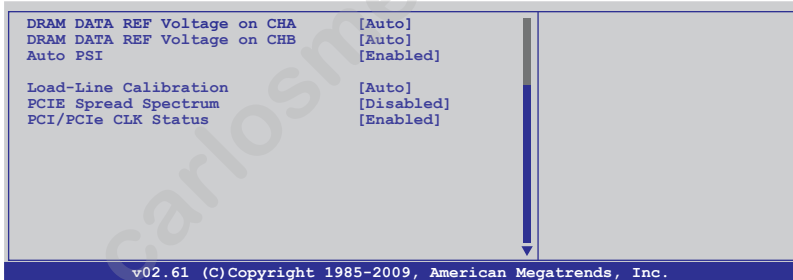

### 2.4.1 Ai Overclock Tuner [Auto]

Allows selection of CPU overclocking options to achieve desired CPU internal frequency. Select either one of the preset overclocking configuration options:

<b>Manual</b>	Allows you to individually set overclocking parameters.
<b>Auto</b>	Loads the optimal settings for the system.
<b>D.O.C.P.</b>	Overclocks DRAM frequency by adjusting BCLK frequency.
<b>X.M.P.</b>	If you install memory module(s) supporting the eXtreme Memory Profile (X.M.P.) Technology, choose this item to set the profile(s) supported by your memory module(s) for optimizing the system performance.



The configuration options for the following sub-item vary depending on the DIMMs you install on the motherboard.

**DRAM O.C. Profile [DDR3-1600MHz]**

This item appears only when you set the **Ai Overclock Tuner** item to [D.O.C.P.] and allows you to select a DRAM O.C. profile, which applies different settings to DRAM frequency, DRAM timing and DRAM voltage.

Configuration options: [DDR3-1600MHz] [DDR3-1800MHz] [DDR3-1866MHz] [DDR3-2000MHz] [DDR3-2133MHz] [DDR3-2200MHz]

DRAM Frequency (MHz)	CPU Frequency (GHz)		
	2.66	2.8	2.93
1333	Auto	Auto	Auto
1600	D.O.C.P.	Auto	Auto
Above 1600	D.O.C.P.	D.O.C.P.	D.O.C.P.



- When using DIMMs with a frequency higher than the Intel® CPU spec, use this ASUS exclusive **DRAM O.C. Profile** function to overclock the DRAM.
- Adjust BCLK frequency to obtain a better performance after applying the D.O.C.P. function.

**eXtreme Memory Profile [Disabled]**

This item appears only when you set the **Ai Overclock Tuner** item to [X.M.P.]



To obtain the best performance of the X.M.P. DIMM or 1600MHz DIMM, install only one DIMM on each memory channel.

## 2.4.2 CPU Ratio Setting [Auto]

Allows you to adjust the ratio between CPU Core Clock and BCLK Frequency. Use the <+> and <-> keys to adjust the value. The valid value ranges differently according to your CPU model.

## 2.4.3 Intel(R) SpeedStep(TM) Tech [Disabled]

When set to [Disabled], the CPU runs at its default speed. When set to [Enabled], the CPU speed is controlled by the operating system. Configuration options: [Disabled] [Enabled]

## 2.4.4 Xtreme Phase Full Power Mode [Auto]

[Auto]

Automatic configuration.

[Enabled]

Enables Full Power Mode to ensure the best CPU overclocking performance.



---

The following two items appear only when you set the **Ai Overclock Tuner** item to [Manual], [D.O.C.P.] or [X.M.P.].

---

### 2.4.5 BCLK Frequency [XXX]

Allows you to adjust the Internal Base Clock (BCLK). Use the <+> and <-> keys to adjust the value. You can also type the desired value using the numeric keypad. The values range from 80 to 500.

### 2.4.6 PCIE Frequency [100]

Allows you to set the PCI Express frequency. Use the <+> and <-> keys to adjust the PCIE frequency. The values range from 100 to 200.

### 2.4.7 DRAM Frequency [Auto]

Allows you to set the DDR3 operating frequency.

Configuration options: [Auto] [DDR3-800MHz] [DDR3-1066MHz] [DDR3-1333MHz]



---

The DRAM Frequency configuration options vary with the BCLK Frequency item settings.

---



---

Selecting a very high DRAM frequency may cause the system to become unstable! If this happens, revert to the default setting.

---

### 2.4.8 QPI Frequency [Auto]

Allows you to set the QPI operating frequency.

Configuration options: [Auto] [4270MHz] [4800MHz]

### 2.4.9 DRAM Timing Control [Auto]

The items in this menu allow you to set the DRAM timing control features.



---

The configuration options for some of the following items vary depending on the DIMMs you install on the motherboard.

---

## 1st Information: 9-9-9-24-4-60-10-7-20

The values vary depending on your settings of the following sub-items:

#### DRAM CAS# Latency [Auto]

Configuration options: [Auto] [3 DRAM Clock] [4 DRAM Clock] ~ [10 DRAM Clock] [11 DRAM Clock]

#### DRAM RAS# to CAS# Delay [Auto]

Configuration options: [Auto] [3 DRAM Clock] [4 DRAM Clock] ~ [9 DRAM Clock] [15 DRAM Clock]

#### DRAM RAS# PRE Time [Auto]

Configuration options: [Auto] [3 DRAM Clock] [4 DRAM Clock] ~ [9 DRAM Clock] [15 DRAM Clock]

#### DRAM RAS# ACT Time [Auto]

Configuration options: [Auto] [3 DRAM Clock] [4 DRAM Clock] ~ [30 DRAM Clock] [31 DRAM Clock]

*DRAM RAS# to RAS# Delay [Auto]*

Configuration options: [Auto] [1 DRAM Clock] ~ [7 DRAM Clock]

*DRAM REF Cycle Time [Auto]*

Configuration options: [Auto] [48 DRAM Clock] [60 DRAM Clock] [72 DRAM Clock] [82 DRAM Clock] ~ [180 DRAM Clock] [190 DRAM Clock] [200 DRAM Clock]

*DRAM WRITE Recovery Time [Auto]*

Configuration options: [Auto] [1 DRAM Clock] ~ [18 DRAM Clock]

*DRAM READ to PRE Time [Auto]*

Configuration options: [Auto] [1 DRAM Clock] ~ [15 DRAM Clock]

*DRAM FOUR ACT WIN Time [Auto]*

Configuration options: [Auto] [1 DRAM Clock] ~ [63 DRAM Clock]

*DRAM Back-To-Back CAS# Delay [Auto]*

Configuration options: [Auto] [4 DRAM Clock] ~ [32 DRAM Clock]

## **2nd Information: 2N-46-0**

The values vary depending on your settings of the following sub-items:

*DRAM Timing Mode [Auto]*

Configuration options: [Auto] [1N] [2N] [3N]

*DRAM Round Trip Latency on CHA [Auto]*

[Auto] [Advance 15 Clock] ~ [Advance 1 Clock] [Normal] [Delay 1 Clock] ~ [Delay 15 Clock]

*DRAM Round Trip Latency on CHB [Auto]*

[Auto] [Advance 15 Clock] ~ [Advance 1 Clock] [Normal] [Delay 1 Clock] ~ [Delay 15 Clock]

## **3rd Information: 5-5-16-10-10-10-7-6-4-7-7-4**

The values vary depending on your settings of the following sub-items:

*DRAM WRITE to READ Delay(DD) [Auto]*

Configuration options: [Auto] [1 DRAM Clock] ~ [8 DRAM Clock]

*DRAM WRITE to READ Delay(DR) [Auto]*

Configuration options: [Auto] [1 DRAM Clock] ~ [8 DRAM Clock]

*DRAM WRITE to READ Delay(SR) [Auto]*

Configuration options: [Auto] [10 DRAM Clock] ~ [22 DRAM Clock]

*DRAM READ to WRITE Delay(DD) [Auto]*

Configuration options: [Auto] [2 DRAM Clock] ~ [14 DRAM Clock]

*DRAM READ to WRITE Delay(DR) [Auto]*

Configuration options: [Auto] [2 DRAM Clock] ~ [14 DRAM Clock]

*DRAM READ to WRITE Delay(SR) [Auto]*

Configuration options: [Auto] [2 DRAM Clock] ~ [14 DRAM Clock]

*DRAM READ to READ Delay(DD) [Auto]*

Configuration options: [Auto] [2 DRAM Clock] ~ [9 DRAM Clock]

*DRAM READ to READ Delay(DR) [Auto]*

Configuration options: [Auto] [2 DRAM Clock] ~ [9 DRAM Clock]

*DRAM READ to READ Delay(SR) [Auto]*

Configuration options: [Auto] [4 DRAM Clock] [6 DRAM Clock]

*DRAM WRITE to WRITE Delay(DD) [Auto]*

Configuration options: [Auto] [2 DRAM Clock] ~ [9 DRAM Clock]

*DRAM WRITE to WRITE Delay(DR) [Auto]*

Configuration options: [Auto] [2 DRAM Clock] ~ [9 DRAM Clock]

*DRAM WRITE to WRITE Delay(SR) [Auto]*

Configuration options: [Auto] [4 DRAM Clock] [6 DRAM Clock]

## 2.4.10 CPU Differential Amplitude [Auto]

Different AMP might enhance BCLK overclocking ability. Configuration options: [Auto] [700mV] [800mV] [900mV] [1000mV]

## 2.4.11 CPU Clock Skew [Auto]

Adjusting this item may help enhancing BCLK overclocking ability. You may need to adjust the **NB Clock Skew** item at the same time.

Configuration options: [Auto] [Normal] [Delay 100ps] ~ [Delay 1500ps]



Some of the following items are adjusted by typing the desired values using the numeric keypad and press the <Enter> key. You can also use the <+> and <-> keys to adjust the value. To restore the default setting, type [auto] using the keyboard and press the <Enter> key.

## 2.4.12 CPU Voltage Mode [Offset]

Allows you to set the CPU Vcore over voltage. Different sub-items appear according to the **VCore Over Voltage** item setting. Configuration options: [Offset] [Manual]

### Offset Voltage [Auto]

This item appears only when you set the **CPU Voltage Mode** item to **[Offset]** and allows you to set the Offset voltage. The values range from 0.00625V to 0.50000V with a 0.00625V interval.

### Fixed Voltage [Auto]

This item appears only when you set the **CPU Voltage Mode** item to **[Manual]** and allows you to set a fixed CPU voltage. The values range from 0.85V to 1.60V with a 0.00625V interval.



Refer to the CPU documentation before setting the CPU Vcore voltage. Setting a high VCore voltage may damage the CPU permanently, and setting a low VCore voltage may make the system unstable.

## 2.4.13 IMC Voltage [Auto]

Allows you to set the CPU Integrated Memory Controller voltage. The values range from 1.10V to 1.45V with a 0.00625V interval.

#### 2.4.14 DRAM Voltage [Auto]

Allows you to set the DRAM voltage. The values range from 1.500V to 2.205V.



---

According to Intel CPU spec, DIMMs with voltage requirement over 1.65V may damage the CPU permanently. We recommend you install the DIMMs with the voltage requirement below 1.65V.

---

#### 2.4.15 CPU PLL Voltage [Auto]

Allows you to set the CPU PLL voltage. The values range from 1.80V to 1.85V with a 0.05V interval.

#### 2.4.16 PCH Voltage [Auto]

Allows you to set the Platform Controller Hub voltage. The values range from 1.05000V to 1.40000V with a 0.00625V interval.



---

The system may need better cooling system to work stably under high voltage settings.

---

#### 2.4.17 DRAM DATA REF Voltage on CHA/B [Auto]

Allows you to set the DRAM DATA Reference Voltage on Channel A/B. The values range from 0.395x to 0.630x with a 0.005x interval. Different ratio might enhance DRAM overclocking ability.

#### 2.4.18 Auto PSI [Enabled]

Enables or disables the Auto PSI mode. Configuration options: [Disabled] [Enabled]

#### 2.4.19 Load-Line Calibration [Auto]

[Auto] Automatic configuration.  
[Disabled] Follow Intel specifications.  
[Enabled] Improve CPU VDroop directly.

#### 2.4.20 PCIe Spread Spectrum [Auto]

[Auto] Automatic configuration.  
[Disabled] Enhances the PCIe overclocking ability.  
[Enabled] Sets to [Enabled] for EMI control.

#### 2.4.11 PCI/PCIe CLK Status [Enabled]

Allows you to enable or disable clock for PCI/PCI Express ports.  
Configuration options: [Disabled] [Enabled]



## 2.5 Advanced menu

The Advanced menu items allow you to change the settings for the CPU and other system devices.



Be cautious when changing the settings of the Advanced menu items. Incorrect field values can cause the system to malfunction.

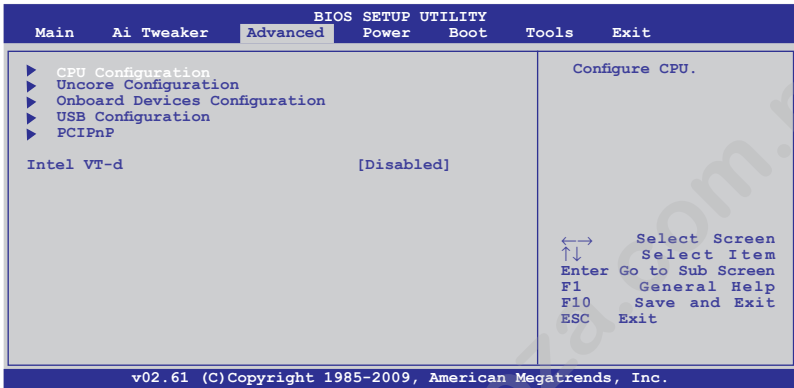

### 2.5.1 CPU Configuration

The items in this menu show the CPU-related information that the BIOS automatically detects.



The items shown in this screen may be different due to the CPU you installed.

#### CPU Ratio Setting [Auto]

Allows you to adjust the ratio between CPU Core Clock and BCLK Frequency. Use the <+> and <-> keys to adjust the value. The valid value ranges differently according to your CPU model.

#### C1E Support [Disabled]

[Enabled] Enables the C1E support function. This item should be enabled in order to enable the Enhanced Halt State.

[Disabled] Disables this function.

#### Hardware Prefetcher [Enabled]

[Enabled] Enables the Hardware Prefetcher function. This item should be enabled in order to enable the L2 cache (MLC) Streamer Prefetcher for tuning performance of the specific application.

[Disabled] Disables this function.

### **Adjacent Cache Line Prefetcher [Enabled]**

[Enabled] Enables the Adjacent Cache Line Prefetcher function. This item should be enabled in order to enable the L2 cache (MLC) Spatial Prefetcher for tuning performance of the specific application.

[Disabled] Disables this function.

### **Max CPUID Value Limit [Disabled]**

[Enabled] Allows legacy operating systems to boot even without support for CPUs with extended CPUID functions.

[Disabled] Disables this function.

### **Intel(R) Virtualization Tech [Enabled]**

[Enabled] Allows a hardware platform to run multiple operating systems separately and simultaneously, enabling one system to virtually function as several systems.

[Disabled] Disables this function.

### **CPU TM function [Enabled]**

[Enabled] Enables the overheated CPU to throttle its clock speed to cool down.

[Disabled] Disables this function.

### **Execute-Disable Bit Capability [Enabled]**

[Enabled] Enables the No-Execution Page Protection Technology.

[Disabled] Forces the XD feature flag to always return to zero (0).

### **Active Processor Cores [All]**

[All] Activate all CPU cores in the processor package.

[1] Activate only 1 CPU core in the processor package.

[2] Activate 2 CPU cores in the processor package.

### **A20M [Disabled]**

[Enabled] Legacy OSES and APs may need this function enabled.

[Disabled] Disables this function.

### **Intel(R) SpeedStep (TM) Tech [Disabled]**

[Enabled] The CPU speed is controlled by the operating system.

[Disabled] The CPU runs at its default speed.

### **Intel(R) C-STATE Tech [Disabled]**

[Enabled] Allows the CPU to save more power under idle mode. Enable this item only when you install a C-State Technology-supported CPU.

[Disabled] Disables this function.

## 2.5.2 Uncore Configuration

The North Bridge Configuration menu allows you to change the advanced chipset settings.

### *Memory Remap Feature [Enabled]*

[Disabled] Do not allow remapping of memory.

[Enabled] Allows for the segment of system memory that was previously overwritten by PCI devices to be remapped above the total physical memory.

### Initiate Graphic Adapter [PCIE/PCI]

Allows you to select the graphics controller as the primary boot device.

Configuration options: [PCI/PCIE] [PCIE/PCI]

## 2.5.3 Onboard Devices Configuration

### HDA Controller [Enabled]

Enables or disables the High Definition Audio Controller.

Configuration options: [Enabled] [Disabled]

### *Front Panel Type [HD Audio]*

Set the front panel audio connector (AAFP) mode.

Configuration options: [AC97] [HD Audio]

### Realtek [Enabled]

[Enabled] Enables the Realtek LAN controller.

[Disabled] Disables the controller.

### *LAN Boot ROM [Disabled]*

This item appears only when you set the previous item to [Enabled].

[Enabled] Enables the Realtek Gigabit LAN Boot ROM.

[Disabled] Disables the LAN Boot ROM.

### VT6415 IDE Controller [Enabled]

Enables or disables the VT6415 IDE Controller. Configuration options: [Enabled] [Disabled]

### Serial Port1 Address [3F8/IRQ4]

Allows you to select the Serial Port1 base address.

Configuration options: [Disabled] [3F8/IRQ4] [2F8/IRQ3] [3E8/IRQ4] [2E8/IRQ3]

### Parallel Port Address [378]

Allows you to select the Parallel Port base addresses. Configuration options: [Disabled] [378] [278] [3BC]

### Parallel Port Mode [Normal]

Allows you to select the Parallel Port mode.

Configuration options: [Normal] [Bi-Directional] [EPP] [ECP] [ECP & EPP]

### *ECP Mode DMA Channel [DMA3]*

Appears only when the Parallel Port Mode is set to [ECP] or [ECP & EPP]. This item allows you to set the Parallel Port ECP DMA. Configuration options: [DMA0] [DMA1] [DMA3]

#### EPP Version [1.9]

Appears only when the Parallel Port Mode is set to [EPP] or [ECP & EPP].  
Configuration options: [1.9] [1.7]

#### Parallel Port IRQ [IRQ7]

Allows you to select parallel port IRQ. Configuration options: [IRQ5] [IRQ7]

## 2.5.4 USB Configuration

The items in this menu allows you to change the USB-related features. Select an item then press <Enter> to display the configuration options.



---

The USB Devices Enabled item shows the auto-detected values. If no USB device is detected, the item shows None.

---

### USB Functions [Enabled]

Enables or disables the USB Host Controllers. Configuration options: [Enabled] [Disabled]



---

The following items appear only when you set USB Support to [Enabled].

---

### Legacy USB Support [Auto]

- [Disabled] Disables the function.
- [Enabled] Enables the support for USB devices on legacy operating systems (OS).
- [Auto] Allows the system to detect the presence of USB devices at startup. If detected, the USB controller legacy mode is enabled. If no USB device is detected, the legacy USB support is disabled.

### BIOS EHCI Hand-off [Enabled]

- [Disabled] Disables the function.
- [Enabled] Enables the support for operating systems without an EHCI hand-off feature.

## 2.5.5 PCIPnP

The PCIPnP menu items allow you to change the advanced settings for PCI/PnP devices.

### Plug And Play O/S [No]

When set to [No], BIOS configures all the devices in the system. When set to [Yes] and if you install a Plug and Play operating system, the operating system configures the Plug and Play devices not required for boot. Configuration options: [No] [Yes]

## 2.5.6 Intel VT-d [Disabled]

Enables or disables the Intel Virtualization Technology for Directed I/O. Configuration options: [Enabled] [Disabled]

## 2.6 Power menu

The Power menu items allow you to change the settings for the Advanced Power Management (APM). Select an item then press <Enter> to display the configuration options.

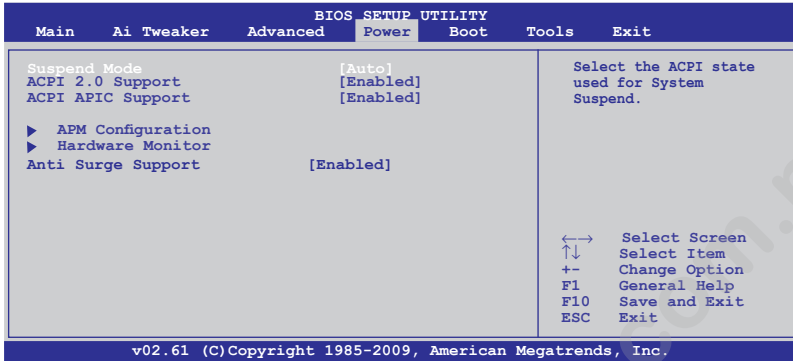

### 2.6.1 Suspend Mode [Auto]

Allows you to select the Advanced Configuration and Power Interface (ACPI) state to be used for system suspend.

[S1 (POS) only] Sets the ACPI suspend mode to S1/POS (Power On Suspend).

[S3 only] Sets the ACPI suspend mode to S3/STR (Suspend To RAM).

[Auto] The system automatically configures the ACPI suspend mode.

### 2.6.2 ACPI 2.0 Support [Enabled]

[Disabled] When set to [Disabled], the system will not add additional tables as per ACPI 2.0 specifications.

[Enabled] When set to [Enabled], the system adds additional tables as per ACPI 2.0 specifications.

### 2.6.3 ACPI APIC Support [Enabled]

[Disabled] When set to [Disabled], the system disable the Advanced Configuration and Power Interface (ACPI) support in the Advanced Programmable Interrupt Controller (APIC).

[Enabled] When set to [Enabled], the ACPI APIC table pointer is included in the RSMDT pointer list.

### 2.6.4 APM Configuration

#### Restore On AC Power Loss [Power Off]

[Power Off] The system goes into off state after an AC power loss.

[Power On] The system goes into on state after an AC power loss.

[Last State] The system goes into either off or on state, whatever the system state was before the AC power loss.

### Power On By RTC Alarm [Disabled]

- [Disabled] Disables RTC to generate a wake event.  
[Enabled] When set to [Enabled], the items **RTC Alarm Date (Days) / System Time** will become user-configurable with set values.

### Power On By External Modems [Disabled]

- [Disabled] Disables to power up the computer when the external modem receives a call while the computer is in Soft-off mode.  
[Enabled] The computer could be powered up when the external modem receives a call while the computer is in Soft-off mode.



---

The computer cannot receive or transmit data until the computer and applications are fully running. Thus, connection cannot be made on the first try. Turning an external modem off and then back on while the computer is off causes an initialization string that turns the system power on.

---

### Power On By PCI Devices [Disabled]

- [Disabled] Disables the PME to wake up from S5 by PCI devices.  
[Enabled] Allows you to turn on the system through a PCI LAN or modem card. This feature requires an ATX power supply that provides at least 1A on the +5VSB lead.

### Power On By PCIE Devices [Disabled]

Allows you to enable or disable the PCIE devices to generate a wake event.

- [Disabled] Disables the PCIE devices to generate a wake event.  
[Enabled] Enables the PCIE devices to generate a wake event.

### Power On By PS/2 Keyboard [Disabled]

Allows you to use specific keys on the keyboard to turn on the system. This feature requires an ATX power supply that provides at least 1A on the +5VSB lead. Configuration options:

[Disabled] [Space Bar] [Ctrl-Esc] [Power Key]

## 2.6.5 Hardware Monitor

### CPU/MB Temperature [xxx°C/xxx°F]

The onboard hardware monitor automatically detects and displays the CPU and motherboard temperatures. Select **Ignored** if you do not wish to display the detected temperatures.

### CPU / Chassis Fan Speed [xxxxRPM] or [Ignored] / [N/A]

The onboard hardware monitor automatically detects and displays the CPU, chassis, and power fan speed in rotations per minute (RPM). If the fan is not connected to the motherboard, the field shows **N/A**. Select **Ignored** if you do not wish to display the detected speed.

### CPU Fan Speed Low Limit [200]

This item appears only when you enable the **CPU Q-Fan Control** feature and allows you to set the low limit of the CPU fan speed. Configuration options: [500] [400] [300] [200] [100] [Ignored]

## CPU Q-Fan Control [Enabled]

[Disabled] Disables the CPU Q-Fan control feature.

[Enabled] Enables the CPU Q-Fan control feature.

### *CPU Fan Profile [Standard]*

This item appears only when you enable the **CPU Q-Fan Control** feature and allows you to set the appropriate performance level of the CPU fan.

[Standard] Sets to [Standard] to make the CPU fan automatically adjust depending on the CPU temperature.

[Silent] Sets to [Silent] to minimize the fan speed for quiet CPU fan operation.

[Turbo] Set to [Turbo] to achieve maximum CPU fan speed.

[Manual] Allows you to individually set the CPU fan parameters.



---

The following items appear only when you set the CPU Fan Profile to [Manual].

---

### **CPU Upper Temperature [70°C/158°F]**

Sets the upper limit of the CPU temperature. Configuration options: [40°C/104°F] [50°C/122°F] [70°C/158°F] [60°C/140°F] [70°C/158°F] [80°C/176°F] [90°C/194°F]

### **CPU Fan Max. Duty Cycle [100%]**

Sets the maximum CPU fan duty cycle. When the CPU temperature reaches the upper limit, the CPU fan will operate at the maximum duty cycle. Configuration options: [20%] [30%] [40%] [50%] [60%] [70%] [80%] [90%] [100%]

### **CPU Lower Temperature [40°C/104°F]**

Displays the lower limit of the CPU temperature.

### **CPU Fan Min. Duty Cycle [20%]**

Sets the minimum CPU fan duty cycle. When the CPU temperature is under 40°C/104°F, the CPU fan will operate at the minimum duty cycle. Configuration options: [00%] [10%] [20%] [30%] [40%] [50%] [60%] [70%] [80%] [90%] [100%]

## CPU Voltage, 3.3V Voltage, 5V Voltage, 12V Voltage

The onboard hardware monitor automatically detects the voltage output through the onboard voltage regulators. Select **Ignored** if you do not want to detect this item.

### 2.6.6 Anti Surge Support [Enabled]

Allows you to enable or disable the Anti-Surge protection feature. Configuration options:

[Disabled] [Enabled]

## 2.7 Boot menu

The Boot menu items allow you to change the system boot options. Select an item then press <Enter> to display the submenu.

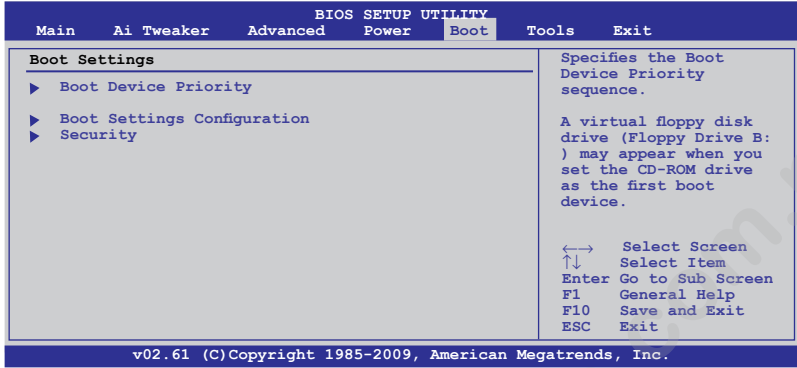

### 2.7.1 Boot Device Priority

#### 1st ~ xxth Boot Device [Removable Dev.]

These items specify the boot device priority sequence from the available devices. The number of device items that appears on the screen depends on the number of devices installed in the system.

Configuration options: [Removable Dev.] [Hard Drive] [ATAPI CD-ROM] [Disabled]



- To select the boot device during system startup, press <F8> when ASUS Logo appears.
- To access Windows® OS in Safe Mode, do any of the following:
  - Press <F5> when ASUS Logo appears.
  - Press <F8> after POST.

### 2.7.2 Boot Settings Configuration

#### Quick Boot [Enabled]

Enabling this item allows the BIOS to skip some power on self tests (POST) while booting to decrease the time needed to boot the system. When this item is set to **[Disabled]**, BIOS performs all the POST items. Configuration options: [Disabled] [Enabled]

#### Full Screen Logo [Enabled]

Enables or disables the full screen logo display feature. Configuration options: [Disabled] [Enabled]



Set this item to **[Enabled]** to use the ASUS MyLogo2™ feature.

#### AddOn ROM Display Mode [Force BIOS]

Sets the display mode for option ROM. Configuration options: [Force BIOS] [Keep Current]



## Bootup Num-Lock [On]

Selects the power-on state for the NumLock. Configuration options: [Off] [On]

## Wait for 'F1' If Error [Enabled]

When this item is set to **[Enabled]**, the system waits for the F1 key to be pressed when error occurs. Configuration options: [Disabled] [Enabled]

## Hit 'DEL' Message Display [Enabled]

When this item is set to **[Enabled]**, the system displays the message **Press DEL to run Setup** during POST. Configuration options: [Disabled] [Enabled]

### 2.7.3 Security

The Security menu items allow you to change the system security settings. Select an item then press **<Enter>** to display the configuration options.

#### Change Supervisor Password

Select this item to set or change the supervisor password. The **Supervisor Password** item on top of the screen shows the default **Not Installed**. After you set a password, this item shows **Installed**.

To set a Supervisor Password:

1. Select the **Change Supervisor Password** item and press **<Enter>**.
2. In the password box, key in a password containing up to six letters or numbers, or both, then press **<Enter>**.
3. Confirm the password when prompted.

The message **Password Installed** appears after you successfully set your password.

To change the supervisor password, follow the same steps as in setting a supervisor password.

To clear the supervisor password, select the **Change Supervisor Password** then press **<Enter>** twice. The message **Password uninstalled** appears.



---

If you forget your BIOS password, you can clear it by erasing the CMOS Real Time Clock (RTC) RAM. See section **1.9 Jumpers** for information on how to erase the RTC RAM.

---

After you have set a supervisor password, the other items appear to allow you to change other security settings.

#### User Access Level [Full Access]

This item allows you to select the access restriction to the Setup items. Configuration options: [No Access] [View Only] [Limited] [Full Access]

**No Access** prevents user access to the Setup utility.

**View Only** allows access but does not allow change to any field.

**Limited** allows changes only to selected fields, such as Date and Time.

**Full Access** allows viewing and changing all the fields in the Setup utility.

#### Change User Password

Select this item to set or change the user password. The **User Password** item on top of the screen shows the default **Not Installed**. After you set a password, this item shows **Installed**.

To set a User Password:

1. Select the **Change User Password** item and press **<Enter>**.
2. In the password box, key in a password containing up to six letters or numbers, or both, then press **<Enter>**.
3. Confirm the password when prompted.

The message **"Password Installed"** appears after you set your password successfully.

To change the user password, follow the same steps as in setting a user password.

### **Clear User Password**

Select this item to clear the user password.

### **Password Check [Setup]**

When this item is set to **[Setup]**, BIOS checks for user password when accessing the Setup utility. When this item is set to **[Always]**, BIOS checks for user password both when accessing Setup and booting the system. Configuration options: [Setup] [Always]

## **2.8 Tools menu**

The Tools menu items allow you to configure options for special functions. Select an item then press **<Enter>** to display the submenu.

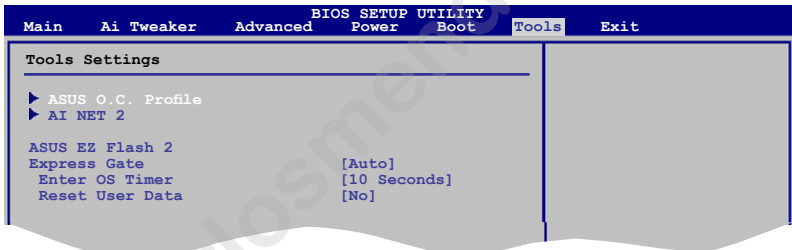

### **2.8.1 ASUS O.C. Profile**

This item allows you to store or load multiple BIOS settings.

#### **Add Your CMOS Profile**

Allows you to save the current BIOS file to the BIOS Flash. In the Name sub-item, type your profile name and press **<Enter>**, and then choose a profile number to save your CMOS settings in the Save to sub-item.

#### **Load CMOS Profiles**

Allows you to load the previous BIOS settings saved in the BIOS Flash. Press **<Enter>**, and choose a profile to load.

#### **Start O.C. Profile**

Allows you to run the utility to save and load CMOS. Press **<Enter>** to run the utility.



- 
- This function can support devices such as a USB flash disk with FAT 32/16 format and single partition only.
  - DO NOT shut down or reset the system while updating the BIOS to prevent the system boot failure!
  - We recommend that you update the BIOS file only coming from the same memory/CPU configuration and BIOS version.
  - Only the CMO file can be loaded.
- 

## 2.8.2 AI NET 2

### Check Realtek LAN cable [Disabled]

Enables or disables checking of the Realtek LAN cable during the Power-On Self-Test (POST). Configuration options: [Disabled] [Enabled]

## 2.8.3 ASUS EZ Flash 2

Allows you to run ASUS EZ Flash 2. When you press <OK>, a confirmation message appears. Use the left/right arrow key to select between [Yes] or [No], then press <OK> to confirm your choice. See section 2.1.2 **ASUS EZ Flash 2** for details.

## 2.8.4 Express Gate [Auto]

Allows you to enable or disable the ASUS Express Gate feature. The ASUS Express Gate feature is a unique instant-on environment that provides quick access to the Internet browser and Skype. Configuration options: [Disabled] [Enabled] [Auto]

### Enter OS Timer [10 Seconds]

Sets countdown duration that the system waits at the Express Gate's first screen before starting Windows or other installed OS. Choose [Prompt User] to stay at the first screen of Express Gate for user action. Configuration options: [Prompt User] [1 second] [3 seconds] [5 seconds] [10 seconds] [15 seconds] [20 seconds] [30 seconds]

### Reset User Data [No]

Allows you to clear Express Gate's user data.

- [Reset] When setting this item to [Reset], ensure that you save the setting to the BIOS so that the user data will be cleared the next time you enter the Express Gate. User data includes the Express Gate's settings as well as any personal information stored by the web browser such as bookmarks, cookies, browsing history. This is useful in the rare case where corrupt settings prevent the Express Gate environment from launching properly.
- [No] Set to [No] to disable the Reset User Data function when entering the Express Gate.



---

The first time wizard will run again when you enter the Express Gate environment after clearing its settings.

---

## 2.9 Exit menu

The **Exit** menu items allow you to load the optimal or failsafe default values for the BIOS items, and save or discard your changes to the BIOS items.

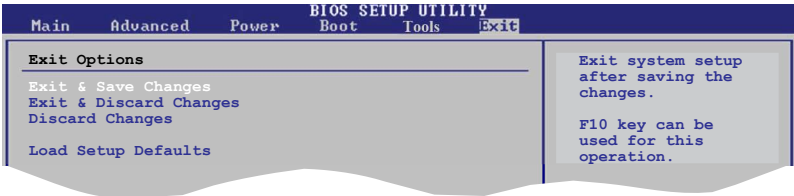

Pressing **<Esc>** does not immediately exit this menu. Select one of the options from this menu or **<F10>** from the legend bar to exit.

### Exit & Save Changes

Once you are finished making your selections, choose this option from the Exit menu to ensure the values you selected are saved to the CMOS RAM. An onboard backup battery sustains the CMOS RAM so it stays on even when the PC is turned off. When you select this option, a confirmation window appears. Select **Ok** to save changes and exit.

### Exit & Discard Changes

Select this option only if you do not want to save the changes that you made to the Setup program. If you made changes to fields other than System Date, System Time, and Password, the BIOS asks for a confirmation before exiting.

### Discard Changes

This option allows you to discard the selections you made and restore the previously saved values. After selecting this option, a confirmation appears. Select **Ok** to discard any changes and load the previously saved values.

### Load Setup Defaults

This option allows you to load the default values for each of the parameters on the Setup menus. When you select this option or if you press **<F5>**, a confirmation window appears. Select **Ok** to load default values. Select **Exit & Save Changes** or make other changes before saving the values to the non-volatile RAM.