

Acme®

N⁵ Neozone

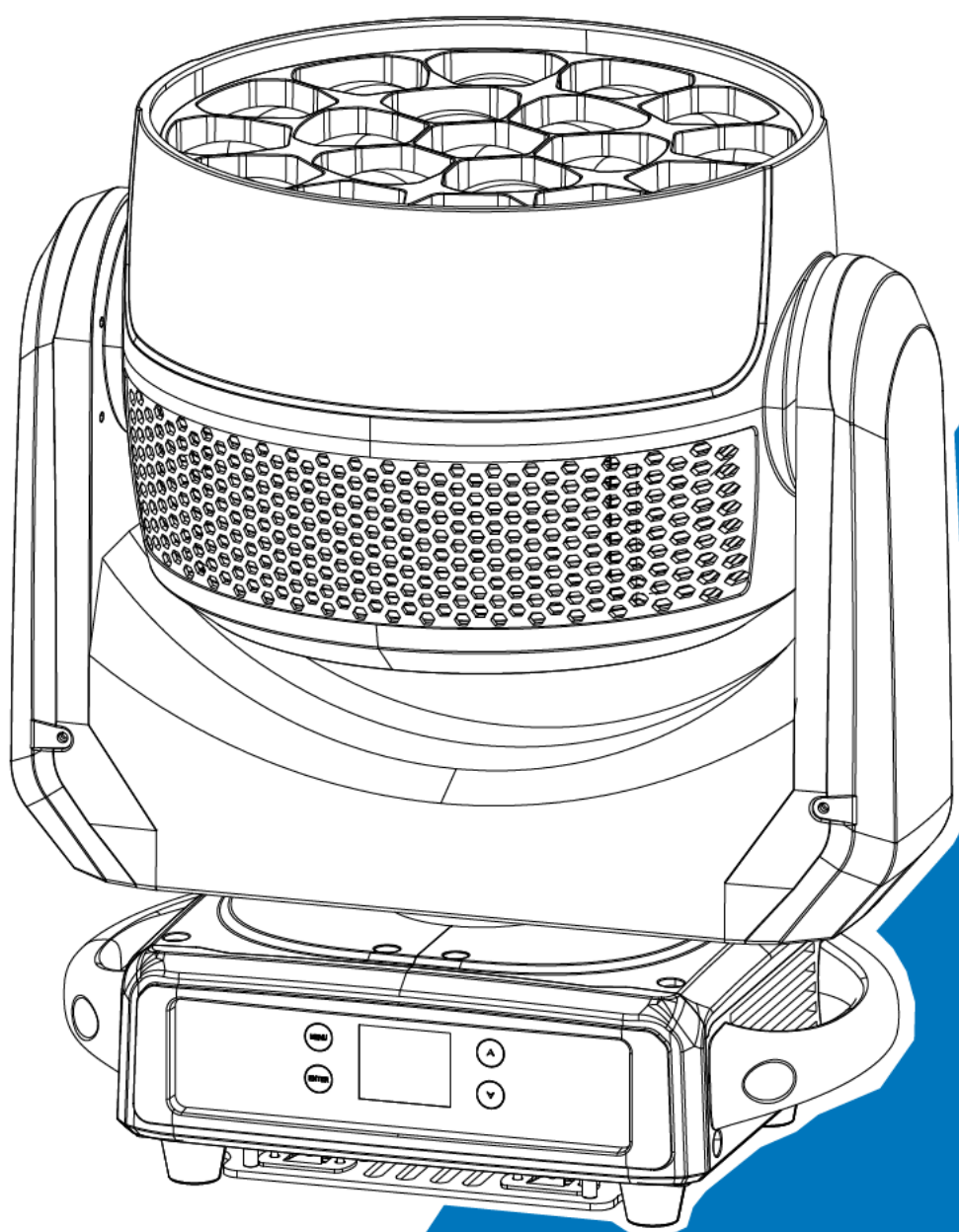

User Manual

Please read the instruction carefully before use

CONTENTS

01/ Safety Information.....	2
02/ Technical Specifications	6
03/ Overview.....	8
04/ Connecting Power and Data	9
4.1 Connecting Power.....	9
4.2 Connecting Data.....	10
05/ Fixture Installation.....	11
06/ Operation.....	13
6.1 Control Menu.....	13
6.2 Home Position Adjustment	27
07/ Configuring the Device for DMX Control.....	30
7.1 Address Setting.....	30
7.2 DMX Protocol	31
08/ Error Information	42
09/ Troubleshooting	47
10/ Fixture Cleaning.....	48
11/ Approvals and Certifications	49

01/ Safety Information



Please read the instruction carefully which includes important information about the installation, usage and maintenance.

WARNING

Please keep this User Manual for future consultation. If you sell the unit to another user be sure that they also receive this instruction manual.

Important:

Damages caused by the disregard of this user manual are not subject to warranty. The dealer will not accept liability for any resulting defects or problems.

- Unpack and check carefully to ensure that there is no transportation damage before using the unit.
- This product is for indoor use only. Use only in a dry location.
- DO install and operate by qualified operator.
- DO NOT allow children to operate the fixture.
- Use safety chain when fixing the unit. Handle the unit by carrying its base instead of head only.
- The unit must be installed in a location with adequate ventilation, at least 50cm from adjacent surfaces.
- Be sure that no ventilation slots is blocked, otherwise the unit will be overheated.
- Before operation, ensure that you are connecting this product to the proper voltage in accordance with the specifications in this manual or on the product's specification label.
- It's important to ground the yellow/green conductor to earth in order to avoid electric shock.
- Minimum ambient temperature TA: 0°C. Maximum ambient temperature TA: 40°C. Do not operate this product at a lower or higher temperature.
- DO NOT connect the device to any dimmer pack.
- Keep flammable materials away from the fixture while operating to avoid fire hazard.
- Make sure the power cord is not crimped or damaged; replace it immediately if damaged.
- Unit's surface temperature may reach up to 75°C. DO NOT touch the housing bare-handed during its operation.
- Avoid any flammable liquids, water or metal from entering the unit. Once it happens, cut

off the mains power immediately.

- DO NOT operate in a dirty or dusty environment. DO clean the fixture regularly.
- DO NOT touch any wire during operation as there might be a hazard of electric shock.
- Avoid entanglement of the power cord with other wires.
- The minimum distance to objects/surface must be more than 0.5 meters.
- Disconnect mains power before fuse replacement or servicing.
- Replace fuse only with the same type.
- In the event of serious operating problem, stop using the unit immediately.
- Never turn on and off the unit time after time.
- The housing, the lenses, or the ultraviolet filter must be replaced if they are visibly damaged.
- DO NOT open the housing as there are no user serviceable parts inside.
- DO NOT attempt to operate this unit if it becomes damaged. DO NOT attempt any repairs yourself. Repairs carried out by unskilled people can lead to damage or malfunction. Please contact the nearest authorized technical assistance center if needed.
- Disconnect this product from its power source before servicing.
- DO use the original packaging if the device is to be transported.
- Avoid direct eye exposure to the light source while the product is on.
- DO NOT operate this product if you see damage on the housing, shields, or cables. Have the damaged parts replaced by an authorized technician at once.

01/ Consignes de sécurité



Veillez lire attentivement les instructions qui contiennent des informations importantes sur l'installation, l'utilisation et l'entretien.

ATTENTION

Veillez conserver ce guide de l'utilisateur pour une consultation future. Si vous vendez l'appareil à un autre utilisateur, assurez-vous qu'il reçoive également ce manuel d'instructions.

Important:

Les dommages causés par le non-respect de ce manuel d'utilisation ne sont pas couverts par la garantie. Le revendeur n'acceptera aucune responsabilité pour les défauts ou problèmes qui en résultent.

- Déballez et vérifiez soigneusement qu'il n'y a pas de dommages dus au transport avant d'utiliser l'appareil.
- Ce produit est destiné à un usage intérieur uniquement. Il doit donc être utilisé uniquement dans un endroit sec.
- L'installation et la mise en fonctionnement doit être effectué par un opérateur qualifié.
- NE PAS permettre aux enfants d'utiliser l'appareil.
- Utilisez une chaîne de sécurité lors de la fixation de l'unité. Manipulez l'appareil en portant sa base au lieu de la tête uniquement.
- L'unité doit être installée dans un endroit avec une ventilation adéquate, à au moins 50cm des surfaces adjacentes.
- Assurez-vous qu'aucune fente d'aération du luminaire n'est obstruée, sinon il risque de surchauffer.
- Avant toute utilisation, assurez-vous que vous connectez ce luminaire à la tension appropriée conformément aux spécifications que vous trouverez dans ce manuel ou sur l'étiquette des spécifications collée sur la base du luminaire.
- Il est important de relier le fil jaune/vert à la terre afin d'éviter tout choc électrique.
- Température ambiante minimale TA: 0°C. Température ambiante maximale TA: 40°C. N'utilisez pas ce luminaire à des températures inférieures ou supérieures.
- NE PAS connecter le luminaire à un pack de gradateurs.
- Gardez les matériaux inflammables à l'écart du luminaire pendant le fonctionnement.

pour éviter tout risque d'incendie.

- Assurez-vous que le cordon d'alimentation n'est pas pincé ou endommagé; remplacez-le immédiatement s'il est endommagé.
 - La température de surface de l'unité peut atteindre 75°C. NE PAS toucher les capots à mains nues pendant son fonctionnement.
 - Évitez que des liquides inflammables, de l'eau ou du métal ne pénètrent dans l'appareil. Si cela se produit, coupez immédiatement l'alimentation secteur.
 - NE PAS utiliser le luminaire dans un environnement sale ou poussiéreux. Cette appareil doit être nettoyer régulièrement.
 - NE touchez AUCUN file pendant le fonctionnement car il pourrait y avoir un risque de choc électrique.
 - Évitez l'enchevêtrement du cordon d'alimentation avec d'autres fils.
 - La distance minimale de projection sur des objets ou sur des surfaces doit être supérieure à 0.5 mètres.
 - Débranchez l'alimentation secteur avant le remplacement ou l'entretien des fusibles.
 - Remplacez le fusible uniquement par un fusible du même type.
 - En cas de problème de fonctionnement grave, arrêtez immédiatement d'utiliser l'appareil.
 - N'allumez et n'éteignez jamais ce luminaire à maintes reprises.
 - Le boîtier, les lentilles ou le filtre ultraviolet doivent être remplacés s'ils sont visiblement endommagés.
 - NE PAS ouvrir le boîtier car il ne contient aucune pièce réparable par l'utilisateur.
 - NE PAS mettre ce luminaire en fonctionnement s'il est endommagé. N'effectuez pas de réparations vous même. Les réparations ne doivent être effectuées par des personnes non qualifiées cela peut entraîner des dommages ou des dysfonctionnements. Veuillez contacter le centre d'assistance technique agréé le plus proche si nécessaire.
 - Débranchez ce produit du secteur avant de procéder à l'entretien.
 - Utiliser l'emballage d'origine si l'appareil doit être transporté.
- Évitez une exposition directe des yeux à la source lumineuse lorsque le produit est allumé.
- N'utilisez PAS ce produit si vous constatez des dommages sur le boîtier, les blindages ou les câbles. Faites remplacer immédiatement les pièces endommagées par un technicien agréé.

02/ Technical Specifications

AC Power	100-240Vac; 50/60Hz	
Max. Power Consumption	960W	
Light Source	19x40W RGBW LED	
Beam Angle	3.5°-28.5°	
Field Angle	5°-50°	
Movement	Pan	540°
	Tilt	220°
	16 bit movement resolution	
	Automatic pan/tilt repositioning	
Control and Programming	DMX Channels	17/21/86/10
	Protocols	DMX512
		RDM
		Art-Net
		sACN
Firmware Updat	via DMX or USB memory device	
Construction	Display	LCD display
	Battery backup for user setup without mains connection	
	DMX and RDM Data In/Out	3-pin XLR (optional with 5-pin XLR)
		RJ45 Connectors
	Power In/Out	Power Connector in/out
	Protection Rating	IP20
Dynamic Effects	19 x RGBW LEDs with individual control	
	0-100% continuous dimming and strobe effects	
	Choice of four dimming curves	
	Motorized zoom	
	Variable color temperature control	
	Outstanding color mixing	
	With color correction system to ensure consistent color output	
	Powerful beam and wash effects	

	2 x fixed clamps for 50mm truss (version with fixed foldable clamps)	
Dimensions	389.6x223x496.4mm (version with omega bracket holes)	15.3"x8.8"x19.5"
Dimensions	389.6x223x530.9mm (version with fixed foldable clamps)	15.3"x8.8"x20.9"
Weight	20 kg (version with omega bracket holes)	44.1 lbs
Weight	21.3 kg (version with fixed foldable clamps)	47 lbs

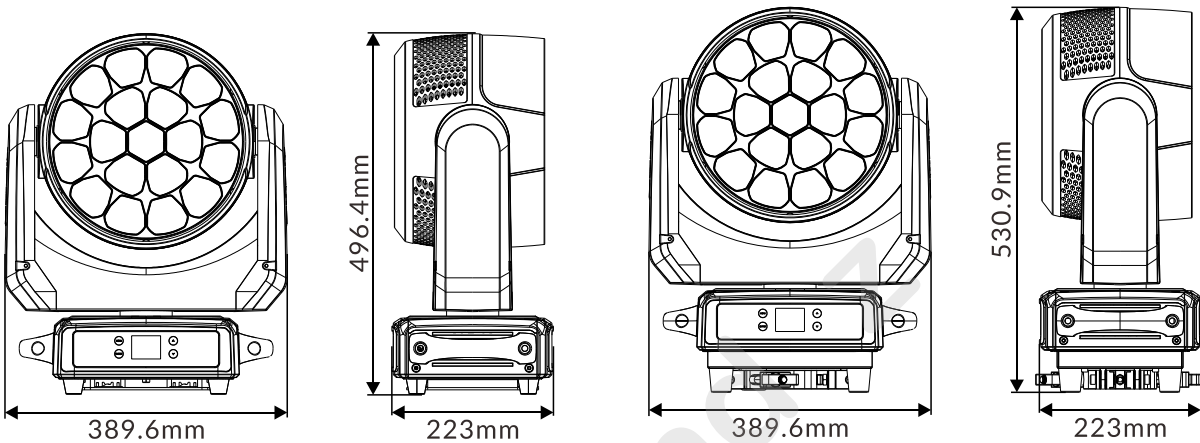

version without fixed clamps

version with fixed clamps

Photometric Diagram:

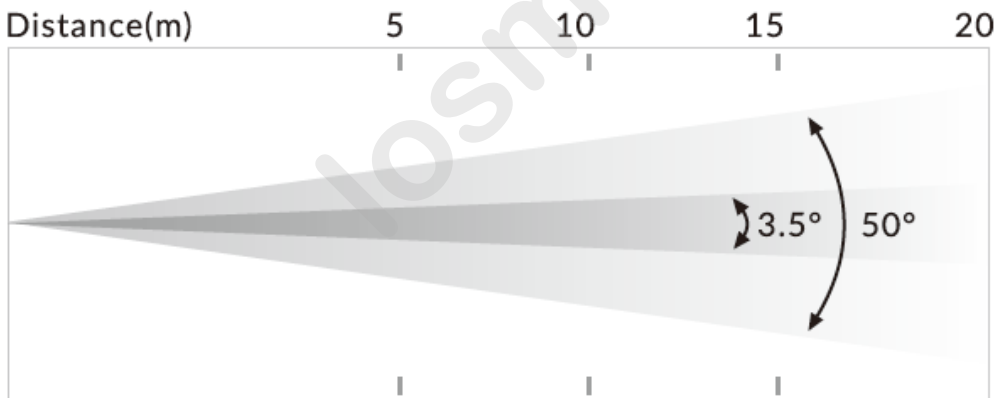

Distance(m)	5	10	15	20
3.5° Lux	51,000	12,750	5,600	3,100
Diameter(m)	0.5	1	1.5	2
50° Lux	2,240	560	240	140
Diameter(m)	4.8	9.6	14.4	19.2

03/ Overview

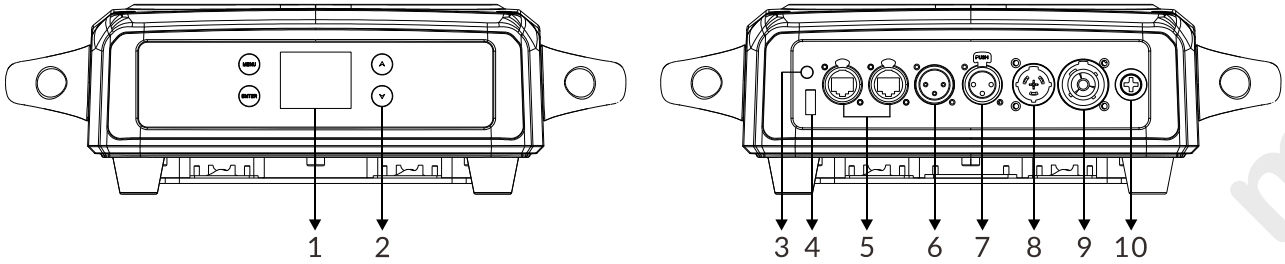

1. Display	To show the various menus and the selected function	
2. Buttons	MENU	To enter into move backward or leave the menu
	▲ UP	To go backward to move up in the menu
	▼ DOWN	To go forward to move down in the menu
	ENTER	To perform the desired functions
3. BATTERY DISPLAY		
4. FIRMWARE UPGRADE	Used to upgrade fixture's firmware	
5. ETHERNET	Transfers fixture's information to a main controller	
6. DMX IN	For DMX512 link use 3-pin XLR cable to link the unit and DMX controller to input DMX signal (optional with 5-pin XLR)	
7. DMX OUT	For DMX512 link, use 3-pin XLR cable to link the next units to output DMX signal (optional with 5-pin XLR)	
8. POWERCON IN	To connect to supply power	
9. POWERCON OUT	To connect to the next fixture	
10. FUSE(T 15A)	Protects the unit from damage of over current or short circuit	

04/ Connecting Power and Data

4.1 Connecting Power

This fixture can operate on any 100-240Vac; 50/60Hz AC mains power supply.

The maximum power consumption is 960W.

The fixture must be grounded/earthed and able to be isolated from AC power. The AC power supply must incorporate a fuse or circuit breaker for fault protection.

Wiring and connection work must be carried out by a qualified electrician.

The power cable color coding is given in the figure below:

Wire	Color (US)	Wire	Color (EU)	Symbol	Conductor
	black		brown	L	live
	white		blue	N	neutral
	green		yellow/green	\perp or \oplus	ground (earth)

Power cord set should be used: Listed SJT flexible cord with rating: 300V, 105°C, 16AWG x 3C, molded with 5-15P attachment plug and terminated with cord connector model SAC3FX with rating 250V, 16A by NINGBO HAISHU DISTRICT SEETRONIC ELECTRONIC CO., LTD.

The power cord shall be at least 914mm (It is to be measured from the face of attachment plug to the face of connector).

CAUTION!

DO NOT CONNECT THE FIXTURE TO AN ELECTRICAL DIMMER SYSTEM AS DOING SO MAY CAUSE DAMAGE.

4.2 Connecting Data

The fixture is equipped with 3-pin (or 5-pin) XLR sockets for DMX input and output. Use a high-quality DMX cable designed for RS-485 and 3-pin (or 5-pin) XLR-plugs and connectors in order to connect the controller with the fixture or one fixture with another.

Building a serial DMX chain:

Connect the DMX data output from the controller to the fixture's data input socket. Connect the DMX output of the first fixture in the DMX chain with the DMX input of the next fixture. Always connect one output with the input of the next fixture until all fixtures are connected. Up to 32 fixtures can be connected to the same DMX link. Terminate the DMX out cable of the last fixture in the data link with a 120 ohm DMX terminator.

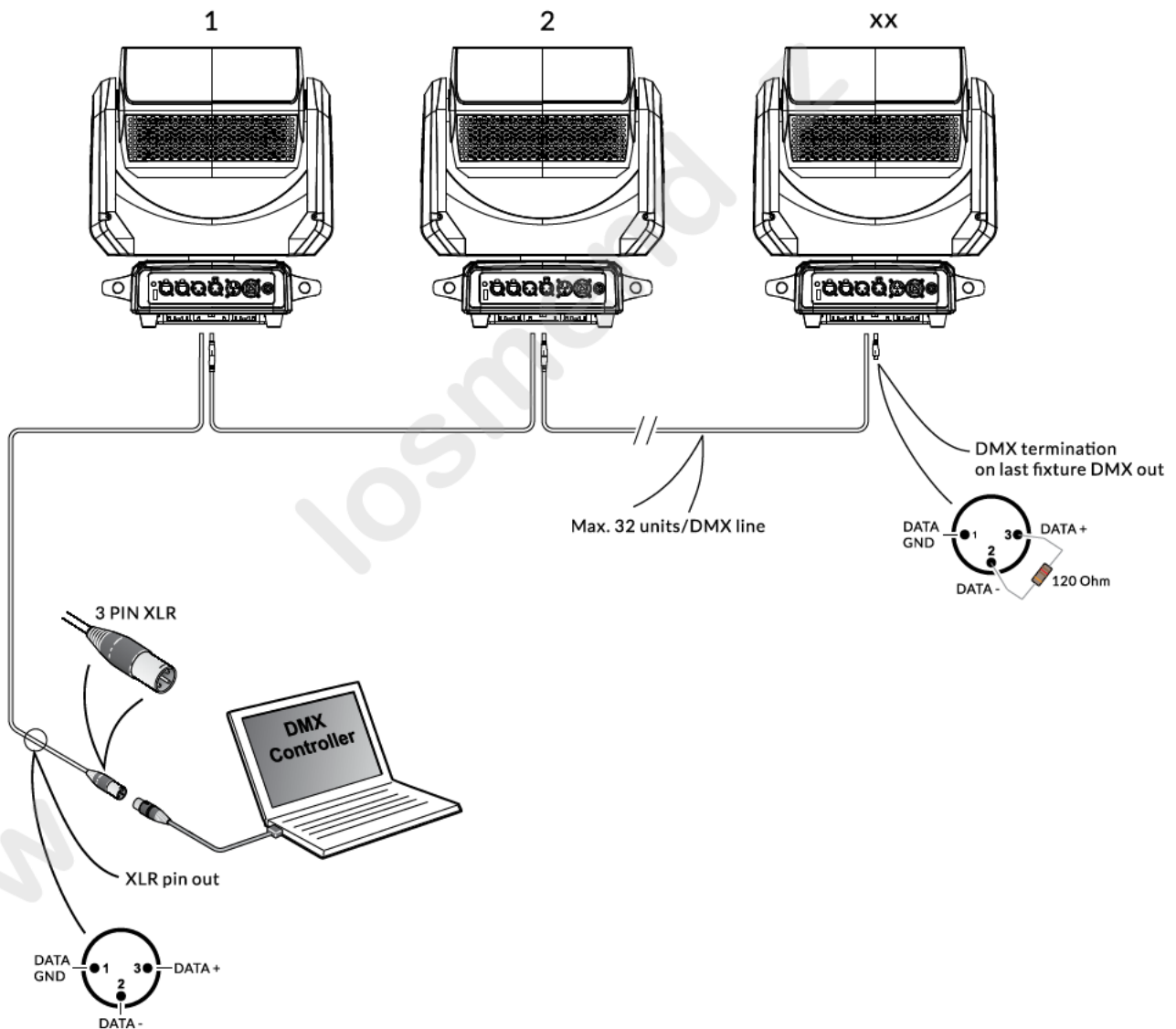

05/ Fixture Installation

- ▶ DO install and operate by qualified operator. Fixture(s) should be installed in areas outside walking paths, seating areas, or away from areas where unauthorized personnel might reach the fixture by hand. NEVER stand directly below the fixture(s) when rigging removing or servicing.
- ▶ Always ensure that the unit is firmly fixed to avoid vibration and slipping off during operation. Ensure that the trussing or area of installation must be able to hold 10 times the weight without any deformation. Always attach a safety cable that can hold at least 12 times the weight of the fixture whenever installing this fixture in a suspended environment to ensure that the fixture will not fall if the clamp fails.
- ▶ This fixture is fully operational in three different mounting positions: hanging upside-down, mounted sideways on trussing, or standing on the floor. Always use and install a safety cable as a safety measure to prevent accidental damage and/or injury in the event the clamp fails.

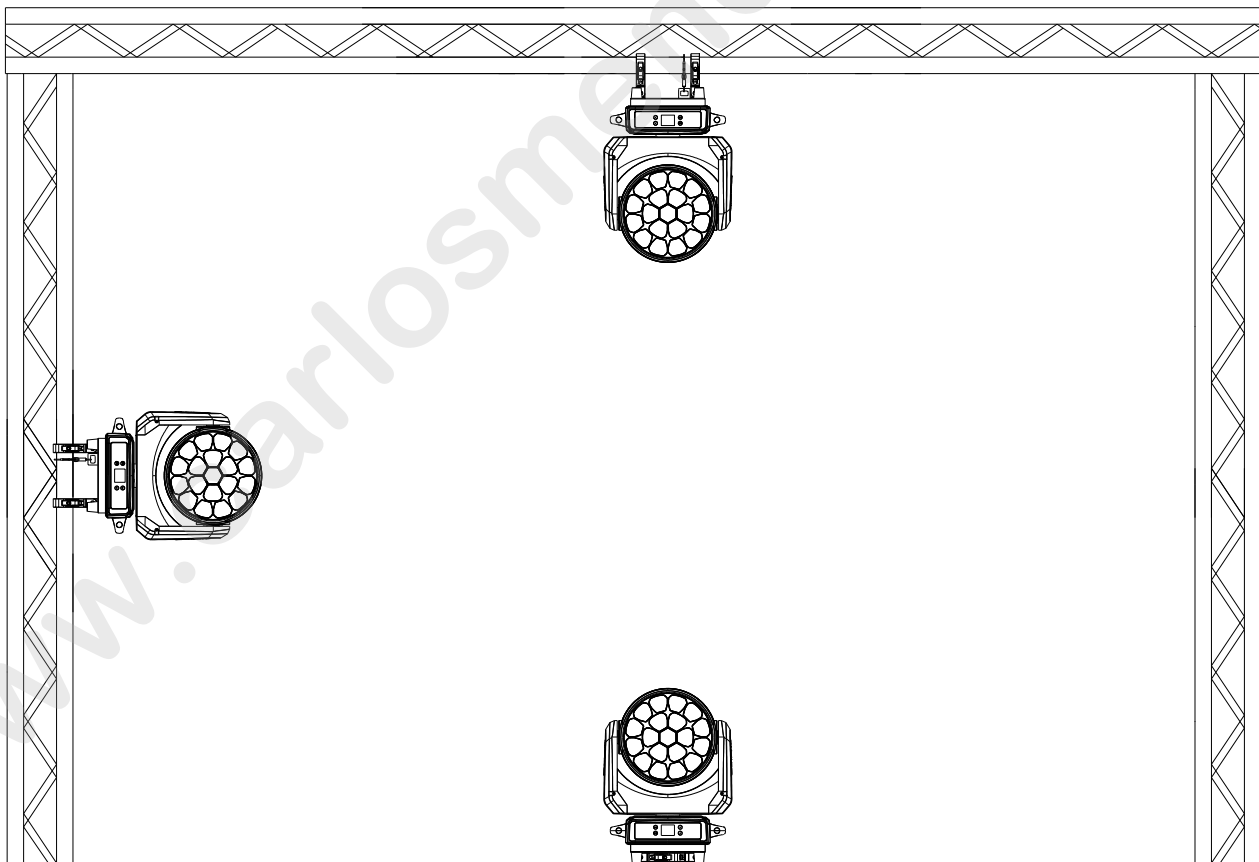

Steps for installing omega brackets to the fixture:

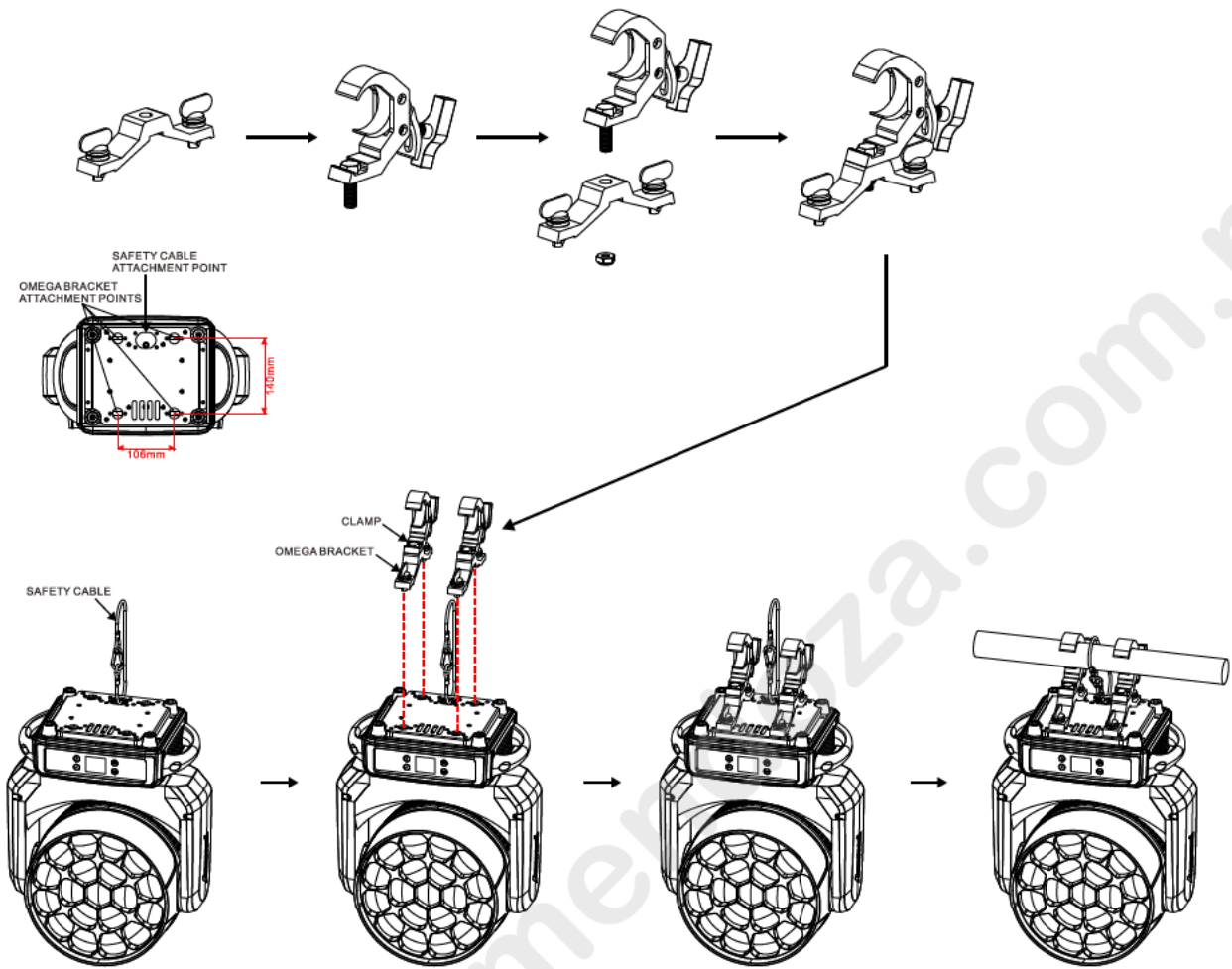

6.1 Control Menu

- ▶ To access the control menus, press the [MENU] button.
- ▶ Navigate the menu structure, using the [ENTER], [▲ UP] and [▼ DOWN] buttons.
- ▶ To select a menu option or to confirm a selection, press the [ENTER] button.
- ▶ To return to a higher level in the menu structure without making a change, press the [MENU] button, or wait 30 seconds.

The main functions are shown below:

MAIN MENU	SUBMENU	CHOICES/VALUES		
DMX Settings	DMX Address	1-496 (17 CH)	(Default 1)	
		1-492 (21 CH)		
		1-427 (86 CH)		
		1-503 (10+ CH)		
	DMX Channel Mode	Mode (1)		
		Mode 2 (21)		
		Mode 3 (86)		
		Mode 4 (10+)		
	No DMX Statu	Blackout		
		Hold		
		Manual		
	View DMX Value			
	Connect Option	Auto		
		DMX		
		Art-Net		
		sACN		
	Network	IP Address	Default 1:002.xxx.xxx.xxx	
			Default 2:010.xxx.xxx.xxx	
			Manual: xxx.xxx.xxx.xxx	
		Subnet Mask	xxx.xxx.xxx.xxx	
Art-Net Settings	Net	0-127	(Default 0)	
	Sub-Net	0-15	(Default 0)	
	Universe	0-15	(Default 0)	
sACN Settings	Universe	1-32000	(Default 1)	
	Priority	0-200	(Default 100)	

MAIN MENU	SUBMENU	CHOICES/VALUES	
	Network to DMX	No	
		Yes	
Fixture Settings	Pan Invert	No	
		Yes	
	Tilt Invert	No	
		Yes	
	P/T Feedback	No	
		Yes	
	Dimmer Speed	Fast	
		Smooth	
	Dimmer Curve	Linear	
		Square Law	
		Inv SQ Law	
		S Curve	
	White Balance	Red	125-255
		Green	125-255
		Blue	125-255
		Red 1	125-255
		Green 1	125-255
		Blue 1	125-255
	
		Red 19	125-255
Green 19		125-255	
Blue 19		125-255	
Colo Calibration	Off		
	On		
Calibration Mode	Hi CRI		
	Hi Output		
Zoom Mode	Long		
	Short		
Cooling Mode	Standard		
	Quiet		
Display Settings	Display Invert	No	
		Yes	
	Backlight Intensity	1-10	(Default 10)
	Temperature Unit	°C	
°F			

MAIN MENU	SUBMENU	CHOICES/VALUES			
	Language	English			
		Chinese			
Fixture Test	Auto Test	Single			
		Cycle			
	Manual Test	Mode 1		Mode 2	
		Clear	No/Yes	Clear	No/Yes
		Pan	0-255	Pan	0-255
		Tilt	0-255	Tilt	0-255
		Zoom	0-255	Zoom	0-255
		Strobe	0-255	Dimmer	0-255
		Dimmer	0-255	Strobe	0-255
		Red 1	0-255	Red	0-255
		Green 1	0-255	Green	0-255
		Blue 1	0-255	Blue	0-255
		White 1	0-2 5	White	0-255
		CTO	0-255
		Red 19	0-255	Color	0-255
		Green 19	0-255	Pixel	0-255
		Blue 19	0-255	Pixel Macro	0-255
		White 19	0-255		
Fixture Information	Fixture Use Hour				
	LED Use Hour	Total LED Hour			
		LED On Hour			
		LED Hours Reset		Password 050	
	Temperature			Current	Max
		LED's	LED 1-3		
		PCBA	CPU-A~G		
	Upgrade File				
	Fan State	B_FAN 1			
		B_FAN 2			
		H_FAN 1			
		H_FAN 2			
	Firmware Version				
	RDM UID				
Error Logs	Fixture Errors				
	Reset Error Log	No			
		Yes	Password 050		

MAIN MENU	SUBMENU	CHOICES/VALUES
Reset Function	Pan/Tilt Reset	No
		Yes
	Effect Reset	No
		Yes
	All Reset	No
		Yes
Special Function	Factory Settings	No
		Yes

DMX Settings

Enter the control menu and select **DMX Settings**, press ENTER. Use the UP/DOWN button to select **DMX Address**, **DMX Channel Mode**, **No DMX Status**, **View DMX Value**, **Connect Option**, **Network**, **Art-Net Settings**, **sACN Settings** or **Network to DMX**.

DMX Address

Select **DMX Address**, press ENTER

Use UP/DOWN button to select an address, confirm your selection with ENTER.

CHANNEL MODE	DMX ADDRESS
Mode 1 (17)	1-496
Mode 2 (21)	1-492
Mode 3 (86)	1-427
Mode 4 (10+)	1-503

To exit the menu, press MENU, or wait 30 seconds.

DMX Channel Mode

Select **DMX Channel Mode**, press ENTER.

Use UP/DOWN button to select between **Mode 1 (17)**, **Mode 2 (21)**, **Mode 3 (86)** and **Mode 4 (10+)**, confirm your selection with ENTER.

To exit the menu, press MENU, or wait 30 seconds.

No DMX Status

Select **No DMX Status**, press ENTER.

Use UP/DOWN button to select one of the following status:

Blackout (Fixture blacks out if DMX signal stops)

Hold (The device continues to operate in the current mode with the last active DMX values until the signal returns)

Manual (The device accepts the DMX value stored in the 'Manual Test' menu)

Confirm your selection with ENTER.

To exit the menu, press MENU, or wait 30 seconds.

View DMX Value

Select **View DMX Value**, press ENTER.

Use UP/DOWN button to select the desired DMX channel, for which the value is to be displayed.

To exit the menu, press MENU or wait 30 seconds.

Connect Option

Select **Connect Option**, press ENTER.

Use UP/DOWN button to select **Auto**, **DMX**, **Art-Net** or **sACN**, confirm your selection with ENTER.

To exit the menu, press MENU, or wait 30 seconds.

Network

Select **Network**, press ENTER.

Use UP/DOWN button to select **IP Address** or **Subnet Mask**, confirm your selection with ENTER.

To exit the menu, press MENU, or wait 30 seconds.

Art-Net Settings

Select **Art-Net Settings**, press ENTER.

Use UP/DOWN button to select **Net**, **Sub-Net** or **Universe**, confirm your selection with ENTER.

To exit the menu, press MENU, or wait 30 seconds.

sACN Settings

Select **sACN Settings**, press ENTER.

Use UP/DOWN button to select **Universe** or **Priority**, confirm your selection with ENTER.

To exit the menu, press MENU, or wait 30 seconds.

Network to DMX

Select **Network to DMX**, press ENTER.

Use UP/DOWN button to select **No** or **Yes**, confirm your selection with ENTER.

To exit the menu, press MENU, or wait 30 seconds.

Fixture Settings

Enter the control menu and select **Fixture Settings**, press ENTER. Use the UP/DOWN button to select **Pan Invert**, **Tilt Invert**, **P/T Feedback**, **Dimmer Speed**, **Dimmer Curve**, **White Balance**, **Color Calibration**, **Calibration Mode**, **Zoom Mode** or **Cooling Mode**.

Pan Invert

Select **Pan Invert**, press ENTER.

Use UP/DOWN button to select **No** (pan invert deactivated) or **Yes** (pan invert activated), confirm your selection with ENTER.

To exit the menu, press MENU, or wait 30 seconds.

Tilt Invert

Select **Tilt Invert**, press ENTER.

Use UP/DOWN button to select **No** (tilt invert deactivated) or **Yes** (tilt invert activated), confirm your selection with ENTER.

To exit the menu, press MENU, or wait 30 seconds.

P/T Feedback

Select **P/T Feedback**, press ENTER.

Use UP/DOWN button to select **No** (pan/tilt feedback deactivated) or **Yes** (pan/tilt feedback activated), confirm your selection with ENTER.

To exit the menu, press MENU, or wait 30 seconds.

Dimmer Speed

Select **Dimmer Speed**, press ENTER.

Use UP/DOWN button to select **Fast** or **Smooth**, confirm your selection with ENTER.

To exit the menu, press MENU, or wait 30 seconds.

Dimmer Curve

Select **Dimmer Curve**, press ENTER.

Use UP/DOWN button to select **Linear**, **Square Law**, **Inv SQ Law** or **S Curve**, confirm your selection with ENTER.

Dimmer Modes

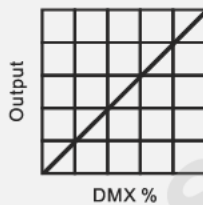

Optically Linear

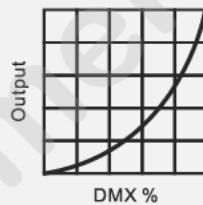

Square Law



Inverse Square Law

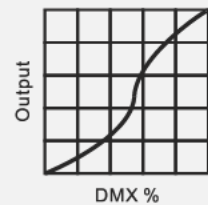

S-curve

To exit the menu, press MENU, or wait 30 seconds.

White Balance

Select **White Balance**, press ENTER.

Use UP/DOWN button to select **Red**, **Green**, **Blue**, **Red1**, **Green1**, **Blue1.....** or **Red19**, **Green19**, **Blue19**, confirm your selection with ENTER.

Use UP/DOWN button to select a value between **125** and **255**, confirm your selection with ENTER.

To exit the menu, press MENU, or wait 30 seconds.

Color Calibration

Select **Color Calibration**, press ENTER.

Use UP/DOWN button to select **Off** or **On**, confirm your selection with ENTER.

To exit the menu, press MENU, or wait 30 seconds.

Calibration Mode

Select **Calibration Mode**, press ENTER.

Use UP/DOWN button to select **Hi CRI** or **Hi Output**, confirm your selection with ENTER.

To exit the menu, press MENU, or wait 30 seconds.

Zoom Mode

Select **Zoom Mode**, press ENTER.

Use UP/DOWN button to select **Long** or **Short**, confirm your selection with ENTER.

To exit the menu, press MENU, or wait 30 seconds.

Cooling Mode

Select **Cooling Mode** press ENTER.

Use UP/DOWN button to select **Standard** or **Quiet**, confirm your selection with ENTER.

To exit the menu, press MENU, or wait 30 seconds.

Display Settings

Enter the control menu and select **Display Settings**, press ENTER. Use the UP/DOWN button to select **Display Invert**, **Backlight Intensity**, **Temperature Unit** or **Language**.

Display Invert

Select **Display Invert**, press ENTER.

Use UP/DOWN button to select **No** (display normal) or **Yes** (display inverted), confirm your selection with ENTER.

To exit the menu, press MENU, or wait 30 seconds.

Backlight Intensity

Select **Backlight Intensity**, press ENTER.

Use UP/DOWN button to select a value between **1** (dark) and **10** (bright), confirm your selection with ENTER.

To exit the menu, press MENU, or wait 30 seconds.

Temperature Unit

Select **Temperature Unit**, press ENTER.

Use UP/DOWN button to select **°C** or **°F**, confirm your selection with ENTER.

To exit the menu, press MENU, or wait 30 seconds.

Language

Select **Language**, press ENTER.

Use UP/DOWN button to select **English** or **Chinese**, confirm your selection with ENTER.

To exit the menu, press MENU, or wait 30 seconds.

Fixture Test

Enter the control menu and select **Fixture Test**, press ENTER. Use the UP/DOWN button to select **Auto Test** or **Manual Test**.

Auto Test

Select **Auto Test**, press ENTER.

Use UP/DOWN button to select **Single** (the device immediately performs a single automatic self-test) or **Cycle** (the device immediately performs a cyclic automatic self-test), confirm your selection with ENTER.

To exit the menu, press MENU.

Manual Test

Select **Manual Test**, press ENTER.

Use UP/DOWN button to select the channel for which the manual test is to be performed, confirm your selection with ENTER.

Use UP/DOWN button to select value, confirm your selection with ENTER.

To exit the menu, press MENU.

(The device returns to its original DMX state after the manual test. The test values are saved automatically when the device is switched off.)

Fixture Information

Enter the control menu and select **Fixture Information**, press ENTER. Use the UP/DOWN button to select **Fixture Use Hour**, **LED Use Hour**, **Temperature**, **Upgrade File**, **Fan State**, **Firmware Version**, **RDM UID** or **Error Logs**.

Fixture Use Hour

Select **Fixture Use Hour**, press ENTER.

The operating hours is displayed.

To exit the menu, press MENU, or wait 30 seconds.

LED Use Hour

Select **LED Use Hour**, press ENTER.

Use UP/DOWN button to select **Total LED Hour** (total time) or **LED On Hour** (current switch-on time), confirm your selection with ENTER.

The total time or current switch-on time is displayed.

Use UP/DOWN button to select **LED Hours Reset**, confirm your selection with ENTER.

Use UP/DOWN button to set the password 050, confirm your selection with ENTER. The LED operating hours is reset.

To exit the menu, press MENU, or wait 30 seconds.

Temperature

Select **Temperature**, press ENTER.

The device temperature is displayed.

To exit the menu, press MENU, or wait 30 seconds.

Upgrade File

Select **Upgrade File**, press ENTER.

The upgrade file is displayed.

To exit the menu, press MENU, or wait 30 seconds.

Fan State

Select **Fan State**, press ENTER.

The fan status is displayed.

To exit the menu, press MENU, or wait 30 seconds.

Firmware Version

Select **Firmware Version**, press ENTER.

The firmware version is displayed.

To exit the menu, press MENU, or wait 30 seconds.

RDM UID

Select **RDM UID**, press ENTER.

The RDM UID is displayed.

To exit the menu, press MENU, or wait 30 seconds.

Error Logs

Select **Error Logs**, press ENTER.

Use UP/DOWN button to select **Fixture Errors**, confirm your selection with ENTER.

The error list is displayed.

Use UP/DOWN button to select **Reset Error Log**, confirm your selection with ENTER.

If you wish to reset the relevant error logs, select **Yes**. If you do not wish to reset anything, select **No**. Confirm your selection with ENTER.

If you select **Yes**, use UP/DOWN button to set the password 050, confirm your selection with ENTER. The relevant error logs are reset.

To exit the menu, press MENU, or wait 30 seconds

Reset Function

Enter the control menu and select **Reset Function** press ENTER. Use the UP/DOWN button to select **Pan/Tilt Reset**, **Effect Reset** or **All Reset**.

Pan/Tilt Reset

Select **Pan/Tilt Reset**, press ENTER.

Use UP/DOWN button to select **No** or **Yes** (the device will run built-in program to reset pan/tilt to their home positions), confirm your selection with ENTER.

To exit the menu, press MENU, or wait 30 seconds.

Effect Reset

Select **Effect Reset**, press ENTER.

Use UP/DOWN button to select **No** or **Yes** (the device will run built-in program to reset effect to their home positions), confirm your selection with ENTER.

To exit the menu, press MENU, or wait 30 seconds.

All Reset

Select **All Reset**, press ENTER.

Use UP/DOWN button to select **No** or **Yes** (the device will run built-in program to reset all to their home positions), confirm your selection with ENTER.

To exit the menu, press MENU, or wait 30 seconds.

Special Function

Enter the control menu and select **Special Function**, press ENTER. Use the UP/DOWN button to select **Factory Settings**.

Factory Settings

Select **Factory Settings**, press ENTER.

If you wish to reset the device to the factory settings, select **Yes**. If you do not wish to reset anything, select **No**. Confirm your selection with ENTER.

To exit the menu, press MENU, or wait 30 seconds.

RDM functions: Certain menus of the device and functions can be called up via the RDM protocol.

The parameter IDs are implemented as follows for different commands:

Parameter ID	Command 'Discovery'	Command 'Set'	Command 'Get'
DISC_UNIQUE_BRANCH	✓		
DISC_MUTE	✓		
DISC_UN_MUTE	✓		
DEVICE_INFO			✓
SUPPORTED_PARAMETERS			✓
SOFTWARE_VERSION_LABEL			✓
DMX_START_ADDRESS		✓	✓
IDENTIFY_DEVICE		✓	✓
DEVICE_MODEL_DESCRIPTION			✓
PARAMETER_DESCRIPTION			✓
MANUFACTURER_LABEL			✓
DEVICE_LABEL		✓	✓
FACTORY_DEFAULTS		✓	✓
BOOT_SOFTWARE_VERSION_ID			✓
BOOT_SOFTWARE_VERSION_LABEL			✓
DMX_PERSONALITY		✓	✓
DMX_PERSONALITY_DESCRIPTION			✓
SENSOR_DEFINITION			✓
SENSOR_VALUE			✓
DEVICE_HOURS			✓
LAMP_HOURS			✓
PAN_INVERT		✓	✓
TILT INVERT		✓	✓
RESET_DEVICE		✓	

✓ -Command implemented for the respective parameter ID

6.2 Home Position Adjustment

- ▶ To access the control menus, press the [MENU] button.
- ▶ To access the offset menus, long-press the [ENTER] button.
- ▶ Navigate the offset menus, using the [ENTER], [▲ UP] and [▼ DOWN] buttons.
- ▶ To select a menu option or to confirm a selection, press the [ENTER] button.
- ▶ To return to a higher level in the menu structure without making a change, press the [MENU] button, or wait 30 seconds.

OFFSET MENU	VALUES
Frequency(Hz)	1072~1327
Pan	-128~127
Tilt	-128~127
Zoom	-128 127
Red 1	0 1000
Green 1	0~1000
Blue 1	0~1000
White 1	0~1000
.....
Red 19	0~1000
Green 19	0~1000
Blue 19	0~1000
White 19	0~1000

Frequency(Hz)

Select **Frequency(Hz)**, press ENTER.

Use UP/DOWN button to select a value between 1072 and 1327, confirm your selection with ENTER.

To exit the offset menu, press MENU, or wait 30 seconds.

Pan

Select **Pan**, press ENTER.

Use UP/DOWN button to select a value between -128 and 127, confirm your selection with ENTER.

To exit the offset menu, press MENU, or wait 30 seconds.

Tilt

Select **Tilt**, press ENTER.

Use UP/DOWN button to select a value between -128 and 127, confirm your selection with ENTER.

To exit the offset menu, press MENU, or wait 30 seconds.

Zoom

Select **Zoom**, press ENTER.

Use UP/DOWN button to select a value between -128 and 127 confirm your selection with ENTER.

To exit the offset menu, press MENU, or wait 30 seconds.

Red 1

Select **Red 1**, press ENTER.

Use UP/DOWN button to select a value between 0 and 1000, confirm your selection with ENTER.

To exit the offset menu, press MENU, or wait 30 seconds.

Green 1

Select **Green 1**, press ENTER.

Use UP/DOWN button to select a value between 0 and 1000, confirm your selection with ENTER.

To exit the offset menu, press MENU, or wait 30 seconds.

Blue 1

Select **Blue 1**, press ENTER.

Use UP/DOWN button to select a value between 0 and 1000, confirm your selection with ENTER.

To exit the offset menu, press MENU, or wait 30 seconds.

White 1

Select **White 1**, press ENTER.

Use UP/DOWN button to select a value between 0 and 1000, confirm your selection with ENTER.

To exit the offset menu, press MENU, or wait 30 seconds.

.....

Red 19

Select **Red 19**, press ENTER.

Use UP/DOWN button to select a value between 0 and 1000, confirm your selection with ENTER.

To exit the offset menu, press MENU, or wait 30 seconds.

Green 19

Select **Green 19**, press ENTER.

Use UP/DOWN button to select a value between 0 and 1000, confirm your selection with ENTER.

To exit the offset menu, press MENU, or wait 30 conds.

Blue 19

Select **Blue 19**, press ENTER.

Use UP/DOWN button to select a value between 0 and 1000, confirm your selection with ENTER.

To exit the offset menu, press MENU, or wait 30 seconds.

White 19

Select **White 19**, press ENTER.

Use UP/DOWN button to select a value between 0 and 1000, confirm your selection with ENTER.

To exit the offset menu, press MENU, or wait 30 seconds.

07/ Configuring the Device for DMX Control

7.1 Address Setting

All fixtures should be given a DMX starting address when operating with a DMX controller, in order to ensure that the correct fixture responds to the correct control signal. Incorrect settings will result in unpredictable responses from the lighting controller.

You can set the same starting address for all fixtures or a group of fixtures, or set different addresses for each individual fixture.

Setting all fixtures to the same DMX address will cause all fixtures to react in the same way. In this case, please note that changing the settings of one channel will affect all the fixtures simultaneously.

If you set each fixture to a different DMX address, each unit will “listen” starting at the channel number you have set, based on the quantity of DMX channels of each fixture. That means changing the settings of one channel will only affect the selected fixture.

For example, if the first fixture is set to 17 ch DMX mode with a start DMX address of 1, the following fixture in the DMX chain should then be set to a DMX address of 18. As the first fixture uses all the first 17 DMX channels the next available channel is 18 (17+1 = 18 >> 18).

See the chart below for more details:

Channel Mode	Unit 1 Address	Unit 2 Address	Unit 3 Address	Unit 4 Address	Unit xxx Address
17 channels	1	18	35	52
21 channels	1	22	43	64
86 channels	1	87	173	259
10+ channels (Controlled by DMX)	1	11	21	31
10 channels (Controlled by Art-Net)	1	77	153	229

7.2 DMX Protocol

CHANNEL				VALUE	FUNCTION
17ch	21ch	86ch	10+ch		
					10+ch (Controlled by DMX)
1	1	1	1	000-255	PAN 0°→540°
2	2	2	2	000-255	PAN FINE
3	3	3	3	000-255	TILT 0°→220°
4	4	4	4	000-255	TILT FINE
		5	5	000-255	PAN/TILT SPEED Fast to Slow
5	5	6	6	000-255	ZOOM Narrow→Wide
7	7	8	8	000-255	DIMMER 0%→100%
8	8	9	9	000-255	DIMMER FINE
9	9	7	7	000-00 008-015 016-131 132-139 140-181 182-189 190-231 232-239 240-247 248-255	STROBE Close Open Strobe from Slow to Fast Open Slow Open Fast Close, Slow to Fast Open Fast Open Slow Close, Slow to Fast Open Random Strobe from Slow to Fast Open
6	6	86	10	000-009 010-019 020-029 030-039 040-049 050-059 060-069 070-079 080-089 090-099 100-109	FUNCTION (To activate following functions, stop in DMX value for at least 3 seconds.) Null Zoom Mode: Long Zoom Mode: Short Dimmer Curve Linear Dimmer Curve Square Law Dimmer Curve Inv SQ Law Dimmer Curve S Null Null Null Led Frequency Setting Enable

				110-119 120-129 130-139 140-149 150-159 160-169 170-179 180-189 190-199 200-209 210-219 220-229 230-239 240-245 246-251 252-255	Led Frequency Setting Disable Null Null Pan/Tilt Reset Effect Reset Color Calibration: On Color Calibration: Off Calibration Mode: High CRI Calibration Mode: High Output All Reset Dimmer Speed Fast Dimmer Speed Smooth Null Cooling Mode: Quiet Cooling Mode: Standard Null
10				000-255	RED 0%→100%
11				000-255	GREEN 0%→100%
12				000-255	BLUE 0%→100%
13				000-255	WHITE 0%→100%
			10+ch (Controlled by Art-Net)		
	10	10	1	000-255	RED 1 0%→100%
	11	11	2	000-255	GREEN 1 0%→100%
	12	12	3	000-255	BLUE 1 0%→100%
	13	13	4	000-255	WHITE 1 0%→100%
	14	14	5	000-255	RED 2 0%→100%
	15	15	6	000-255	GREEN 2 0%→100%
	16	16	7	000-255	BLUE 2 0%→100%
	17	17	8	000-255	WHITE 2 0%→100%
	18	18	9	000-255	RED 3 0%→100%
	19	19	10	000-255	GREEN 3 0%→100%

	20	20	11	000-255	BLUE 3 0%→100%
	21	21	12	000-255	WHITE 3 0%→100%
		22	13	000-255	RED 4 0%→100%
		23	14	000-255	GREEN 4 0%→100%
		24	15	000-255	BLUE 4 0%→100%
		25	16	000-255	WHITE 4 0%→100%
		26	17	000-255	RED 5 0%→100%
		27	18	000-255	GREEN 5 0%→100%
		28	19	000-255	BLUE 5 0%→100%
		29	20	000-255	WHITE 5 0%→100%
		30	21	000-255	RED 6 0%→100%
		31	22	000-255	GREEN 6 0%→100%
		32	23	000-255	BLUE 6 0%→100%
		33	24	000-255	WHITE 6 0%→100%
		34	25	000-255	RED 7 0%→100%
		35	26	000-255	GREEN 7 0%→100%
		36	27	000-255	BLUE 7 0%→100%
		37	28	000-255	WHITE 7 0%→100%
		38	29	000-255	RED 8 0%→100%
		39	30	000-255	GREEN 8 0%→100%
		40	31	000-255	BLUE 8 0%→100%
		41	32	000-255	WHITE 8 0%→100%

		42	33	000-255	RED 9 0%→100%
		43	34	000-255	GREEN 9 0%→100%
		44	35	000-255	BLUE 9 0%→100%
		45	36	000-255	WHITE 9 0%→100%
		46	37	000-255	RED 10 0%→100%
		47	38	000-255	GREEN 10 0%→100%
		48	39	000-255	BLUE 10 0%→100%
		49	40	000-255	WHITE 10 0% 100%
		50	41	000-255	RED 11 0%→100%
		51	42	000-255	GREEN 11 0%→100%
		52	43	000-255	BLUE 11 0%→100%
		53	44	000-255	WHITE 11 0%→100%
		54	45	000-255	RED 12 0%→100%
		55	46	000-255	GREEN 12 0%→100%
		56	47	000-255	BLUE 12 0%→100%
		57	48	000-255	WHITE 12 0%→100%
		58	49	000-255	RED 13 0%→100%
		59	50	000-255	GREEN 13 0%→100%
		60	51	000-255	BLUE 13 0%→100%
		61	52	000-255	WHITE 13 0%→100%
		62	53	000-255	RED 14 0%→100%
		63	54	000-255	GREEN 14 0%→100%

		64	55	000-255	BLUE 14 0%→100%
		65	56	000-255	WHITE 14 0%→100%
		66	57	000-255	RED 15 0%→100%
		67	58	000-255	GREEN 15 0%→100%
		68	59	000-255	BLUE 15 0%→100%
		69	60	000-255	WHITE 15 0%→100%
		70	61	000-255	RED 16 0%→100%
		71	62	000-255	GREEN 16 0% 100%
		72	63	000-255	BLUE 16 0%→100%
		73	64	000-255	WHITE 16 0%→100%
		74	65	000-255	RED 17 0%→100%
		75	66	000-255	GREEN 17 0%→100%
		76	67	000-255	BLUE 17 0%→100%
		77	68	000-255	WHITE 17 0%→100%
		78	69	000-255	RED 18 0%→100%
		79	70	000-255	GREEN 18 0%→100%
		80	71	000-255	BLUE 18 0%→100%
		81	72	000-255	WHITE 18 0%→100%
		82	73	000-255	RED 19 0%→100%
		83	74	000-255	GREEN 19 0%→100%
		84	75	000-255	BLUE 19 0%→100%
		85	76	000-255	WHITE 19 0%→100%

14

























































































000	CTO (8000K-2500K)
001-004	8000K
005-009	7900K
010-013	7800K
014-018	7700K
019-022	7600K
023-027	7500K
028-031	7400K
032-036	7300K
037-040	7200K
041-045	7100K
046-049	7000K
050-054	6900K
055-058	6800K
059-063	6700K
064-067	6600K
068-072	6500K
073-076	6400K
077-081	6300K
082-085	6200K
086-090	6100K
091-094	6000K
095-099	5900K
100-103	5800K
104-108	5700K
109-112	5600K
113-117	5500K
118-121	5400K
122-126	5300K
127-130	5200K
131-135	5100K
136-139	5000K
140-144	4900K
145-148	4800K
149-153	4700K
154-157	4600K
158-162	4500K
163-166	4400K
167-171	4300K
172-175	4200K
176-180	4100K
181-184	4000K
185-189	3900K
190-193	3800K
194-198	3700K
199-202	3600K
203-207	3500K

























































































				208-211	3400K
				212-216	3300K
				217-220	3200K
				221-225	3100K
				226-229	3000K
				230-234	2900K
				235-238	2800K
				239-243	2700K
				244-247	2600K
				248-255	2500K
					COLOR MACRO
				000-007	Null
				008-011	Color 1
				012-015	Color 2
				016-019	Color 3
				020-023	Color 4
				024-027	Color 5
				028-031	Color 6
				032-035	Color 7
				036-039	Color 8
				040-043	Color 9
				044-047	Color 10
				048-051	Color 11
				052-055	Color 12
				056-059	Color 13
				060-063	Color 14
				064-067	Color 15
				068-071	Color 16
				072-075	Color 17
				076-079	Color 18
				080-083	Color 19
				084-087	Color 20
				088-091	Color 21
				092-095	Color 22
				096-099	Color 23
				100-103	Color 24
				104-107	Color 25
				108-111	Color 26
				112-115	Color 27
				116-119	Color 28
				120-123	Color 29
				124-127	Color 30
				128-131	Color 31
				132-135	Color 32
				136-165	Rotate CW Fast to Slow
				166-195	Rotate CCW Slow to Fast
				196-205	Red→Green















































































15

				206-215 216-225 226-235 236-245 246-255	Red→Blue Red→White Green→Blue Green→White Blue→White
16				000 001 002-245 246 247 248 249 250 251-255	PIXEL (See "Pixel of 16 CH" in detail) Null Open Pattern1-244 Built-in Mode1 Built-in Mode2 Built-in Mode3 Random One Pixel Random Two Pixels Open
17				000-031 032-091 092-101 102-161 162-255	PIXEL ROTATION Null Rotate CW Fast to Slow Null Rotate CCW Slow to Fast Null

Pixel of 16 CH:

 Value : 000	 Value : 001	 Value : 002	 Value : 003	 Value : 004	 Value : 005	 Value : 006	 Value : 007
 Value : 008	 Value : 009	 Value : 010	 Value : 011	 Value : 012	 Value : 013	 Value : 014	 Value : 015
 Value : 016	 Value : 017	 Value : 018	 Value : 019	 Value : 020	 Value : 021	 Value : 022	 Value : 023
 Value : 024	 Value : 025	 Value : 026	 Value : 027	 Value : 028	 Value : 029	 Value : 030	 Value : 031
 Value : 032	 Value : 033	 Value : 034	 Value : 035	 Value : 036	 Value : 037	 Value : 038	 Value : 039
 Value : 040	 Value : 041	 Value : 042	 Value : 043	 Value : 044	 Value : 045	 Value : 046	 Value : 047
 Value : 048	 Value : 049	 Value : 050	 Value : 051	 Value : 052	 Value : 053	 Value : 054	 Value : 055
 Value : 056	 Value : 057	 Value : 058	 Value : 059	 Value : 060	 Value : 061	 Value : 062	 Value : 063
 Value : 064	 Value : 065	 Value : 066	 Value : 067	 Value : 068	 Value : 069	 Value : 070	 Value : 071
 Value : 072	 Value : 073	 Value : 074	 Value : 075	 Value : 076	 Value : 077	 Value : 078	 Value : 079
 Value : 080	 Value : 081	 Value : 082	 Value : 083	 Value : 084	 Value : 085	 Value : 086	 Value : 087

 Value: 088	 Value: 089	 Value: 090	 Value: 091	 Value: 092	 Value: 093	 Value: 094	 Value: 095
 Value: 096	 Value: 097	 Value: 098	 Value: 099	 Value: 100	 Value: 101	 Value: 102	 Value: 103
 Value: 104	 Value: 105	 Value: 106	 Value: 107	 Value: 108	 Value: 109	 Value: 110	 Value: 111
 Value: 112	 Value: 113	 Value: 114	 Value: 115	 Value: 116	 Value: 117	 Value: 118	 Value: 119
 Value: 120	 Value: 121	 Value: 122	 Value: 123	 Value: 124	 Value: 125	 Value: 126	 Value: 127
 Value: 128	 Value: 129	 Value: 130	 Value: 131	 Value: 132	 Value: 133	 Value: 134	 Value: 135
 Value: 136	 Value: 137	 Value: 138	 Value: 139	 Value: 140	 Value: 141	 Value: 142	 Value: 143
 Value: 144	 Value: 145	 Value: 146	 Value: 147	 Value: 148	 Value: 149	 Value: 150	 Value: 151
 Value: 152	 Value: 153	 Value: 154	 Value: 155	 Value: 156	 Value: 157	 Value: 158	 Value: 159
 Value: 160	 Value: 161	 Value: 162	 Value: 163	 Value: 164	 Value: 165	 Value: 166	 Value: 167
 Value: 168	 Value: 169	 Value: 170	 Value: 171	 Value: 172	 Value: 173	 Value: 174	 Value: 175

 Value: 176	 Value: 177	 Value: 178	 Value: 179	 Value: 180	 Value: 181	 Value: 182	 Value: 183
 Value: 184	 Value: 185	 Value: 186	 Value: 187	 Value: 188	 Value: 189	 Value: 190	 Value: 191
 Value: 192	 Value: 193	 Value: 194	 Value: 195	 Value: 196	 Value: 197	 Value: 198	 Value: 199
 Value: 200	 Value: 201	 Value: 202	 Value: 203	 Value: 204	 Value: 205	 Value: 206	 Value: 207
 Value: 208	 Value: 209	 Value: 210	 Value: 211	 Value: 212	 Value: 213	 Value: 214	 Value: 215
 Value: 216	 Value: 217	 Value: 218	 Value: 219	 Value: 220	 Value: 221	 Value: 222	 Value: 223
 Value: 224	 Value: 225	 Value: 226	 Value: 227	 Value: 228	 Value: 229	 Value: 230	 Value: 231
 Value: 232	 Value: 233	 Value: 234	 Value: 235	 Value: 236	 Value: 237	 Value: 238	 Value: 239
 Value: 240	 Value: 241	 Value: 242	 Value: 243	 Value: 244	 Value: 245		
 Value: 246	 Value: 247						
 Value: 248	 Value: 249	 Value: 250	 Value: 251	 Value: 250	 Value: 251		
			Value: 249 Randomly	Value: 250 Randomly	Value: 251-255		

08/ Error Information

Error codes are shown continuously in the display when the fixture fails and they will not disappear until the fixture is repaired.

CPU-B/C/D/E/F Error

Check whether the 485 (DATA) leads on the PCB board are installed in place or disconnected.

Check whether the related 485 (DATA) signal circuit on the PCB board is damaged.

Pan Reset Error

Check whether the position of the pan where the magnet is installed falls off or is damaged.

Check whether there are obstacles in the pan operating range.

Check whether the Hall element on the pan is damaged.

Check whether the lead connecting the Hall element on the pan and the PCB board is in poor contact or disconnected.

Check whether the motor on the pan is damaged.

Check whether the related circuit of the motor drive board on the pan is damaged.

Pan Encode Error

Check whether the encoder on the pan is damaged.

Check whether the lead connecting the encoder on the pan and the PCB board is in poor contact or disconnected.

Tilt Reset Error

Check whether the position of the tilt where the magnet is installed falls off or is damaged.

Check whether there are obstacles in the tilt operating range.

Check whether the Hall element on the tilt is damaged.

Check whether the lead connecting the Hall element on the tilt and the PCB board is in poor contact or disconnected.

Check whether the motor on the tilt is damaged.

Check whether the related circuit of the motor drive board on the tilt is damage.

Tilt Encode Error

Check whether the encoder on the tilt is damaged.

Check whether the lead connecting the encoder on the tilt and the PCB board is in poor contact or disconnected.

Zoom Reset Error

Check whether the position of the zoom where the magnet is installed falls off or is damaged.

Check whether there are obstacles in the zoom operating range.

Check whether the Hall element on the zoom is damaged.

Check whether the lead connecting the Hall element on the zoom and the PCB board is in poor contact or disconnected.

Check whether the motor on the zoom is damaged.

Check whether the related circuit of the motor drive board on the zoom is damage.

LED Temp. 1/2/3 Error

Check whether the temperature detecting board is normal.

Check whether the components of the temperature detecting board are damaged.

Check whether the lead on the temperature detecting board is installed in place or disconnected.

LED Timeout Use

LED Too Hot Off

When the fixture temperature reaches 85°C, it will automatically turn off to protect the fixture.

Base Fan 1/2 Start Err

Check whether the fan is not running

Check whether the fan leads are installed in place or disconnected.

Check whether the fan is damaged.

Check whether there are obstacles in the fan operating range.

Base Fan 1/2 Stop Err

Check whether the fan circuit on the motherboard breaks down.

Check whether the component is damaged.

Base Fan 1/2 Too Low

Check whether the fan is out of order.

Check whether there are obstacles in the fan operating range.

Base Fan 1/2 Too High

Check whether the fan is out of order.

Check whether the fan circuit on the motherboard breaks down.

Head Fan 1/2 Start Err

- Check whether the fan is not running.
- Check whether the fan leads are installed in place or disconnected.
- Check whether the fan is damaged.
- Check whether there are obstacles in the fan operating range.

Head Fan 1/2 Stop Err

- Check whether the fan circuit on the motherboard breaks down.
- Check whether the component is damaged.

Head Fan 1/2 Too Low

- Check whether the fan is out of order.
- Check whether there are obstacles in the fan operating range.

Head Fan 1/2 Too High

- Check whether the fan is out of order.
- Check whether the fan circuit on the motherboard breaks down.

Color Cal IC Error

- Check if the color calibration IC is damaged.
- Check whether the color calibration IC board is inserted well and whether the electronic components are well soldered.
- Check if the motherboard is malfunctioning.
- Check whether the R76 bit resistors and other components on the motherboard are well soldered.

Position of cooling fans:

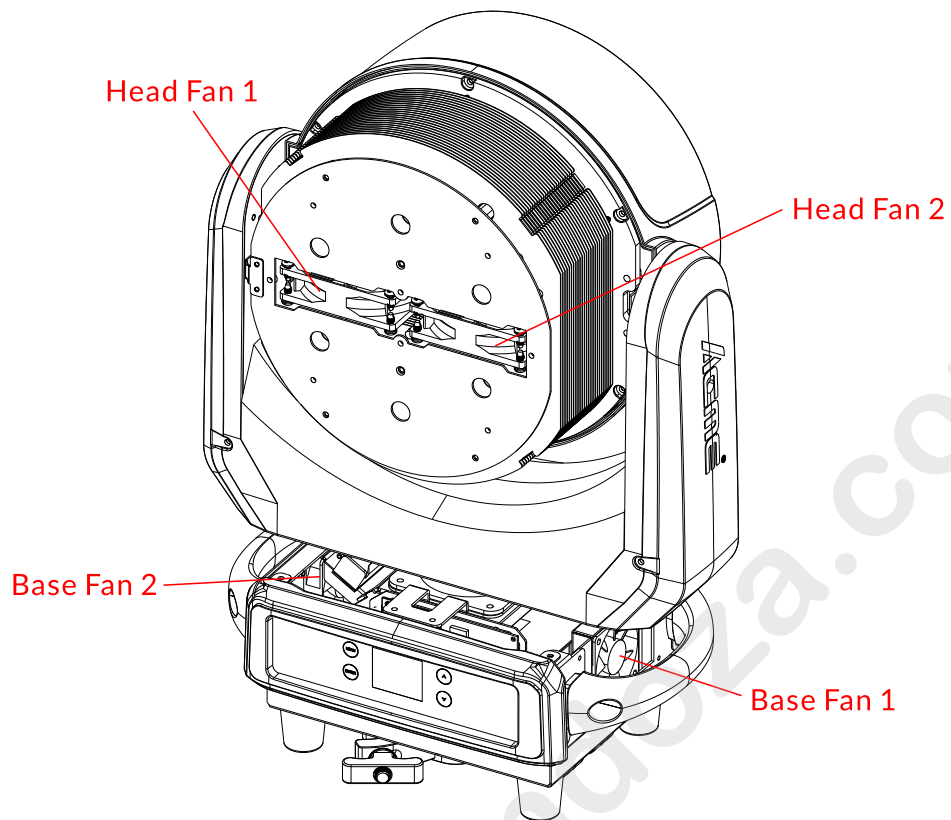

Cooling Fans	Part Number	V	W	Position
Head Fan 1	3014001310	DC 24V	3.8W	Head - C
Head Fan 2				
Base Fan 1	3014001330	DC 24V	4W	Base - A
Base Fan 2				

09/ Troubleshooting

Problem	Potential cause(s)	Remedies
Fixture does not respond or appears to be off.	No power to the fixture.	Confirm that the power is switched on and cables are plugged in.
	No output from PSU.	Replace the PSU.
Fixture suddenly turned off.	Power was turned off.	Check the power supply, switches and breakers.
Light output cuts out intermittently.	Fixture is too hot.	Check fixture's stored error messages for more information. Allow fixture to cool Clean fixture. Reduce ambient temperature.
Fixture suddenly stopped responding.	DMX cables were disconnected.	Inspect DMX cables.
Fixture operates irregularly / abnormal.	Incorrect DMX address or DMX mode.	Inspect and enter the correct DMX address or mode.
	DMX link is not terminated.	Install a XLR 120ohm DMX termination at the end of the DMX link.
	Bad data link.	Replace or repair defective cables and/or connections.
	One of the fixtures is defective and is disturbing data transmission on the link.	Track and isolate the corrupted fixture. Have the fixture serviced by a qualified technician.
Pan / tilt is skipping / shuddering	Obstacles are within the required pan / tilt clearance.	Inspect and remove any obstacles constraining free operation of the pan / tilt.
	The Hall element is damaged.	Replace the Hall element.
	The magnetic steel fell out.	Replace the magnetic steel.

10/ Fixture Cleaning

Regular cleaning is very important for fixture life and performance. Buildup of dust, dirt, smoke particles, fog fluid residues, etc. degrades the fixture's light output and cooling ability. Cleaning schedules for lighting fixtures vary greatly depending on the operating environment. It is therefore impossible to specify precise cleaning intervals for the fixture. Environmental factors that may result in a need for frequent cleaning include:

- ▶ Use of smoke or fog machines.
- ▶ High airflow rates (near air conditioning vents, for example).
- ▶ Airborne dust (from stage effects, building structures and fittings or the natural environment at outdoor events, for example).

If one or more of these factors is present, inspect fixtures within their first few hours of operation to see whether cleaning is necessary. Check again at frequent intervals. This procedure will allow you to assess cleaning requirements in your particular situation.

Follow these precautions when cleaning the fixture:

- ▶ Work in a clean, dry, well-lit area.
- ▶ Use gentle pressure only. A soft lint-free cloth dampened with a solution of water and a mild detergent is recommended, under no circumstances should alcohol, solvents or abrasives be used! Use care when cleaning optical components: surfaces are fragile and easily scratched.

11/ Approvals and Certifications

This product has been tested and found to comply with the following standards:

- 2014/30/EU - Electromagnetic Compatibility (EMC)
- 2014/35/EU - Low Voltage Directive (LVD)
- cETLus Approved (Control #5000057)



The information in this document is subject to change without notice.

For the latest information, visit www.acmelighting.com.



www.acmelighting.com